

SPŁUCZKINADTYNKOWE

EXPOSED FLUSH CISTERNS
RÉSERVOIRS APPARENTS



PONADZASOWA KLASYKA

A TIMELESS CLASSIC

UN CLASSIQUE INTEMPOREL

CHARAKTERYSTYKA







- Szeroka gama rozwiązań dla wszystkich rodzajów instalacji.
- Możliwość podwójnego spłukiwania z wyborem pełnej lub częściowej objętości spłukiwania.
- Możliwość spłukiwania za pomocą pneumatycznego mechanizmu.
- Cały asortyment spłuczek dostarczany jest z powłoką antykondensacyjną.
- Możliwość montażu spłuczki w niskim, pośrednim i wysokim położeniu.
- Możliwość stosowania z miskami kompaktowymi.
- Specjalnie zaprojektowany dla toalet publicznych, charakteryzuje się odpornością na przypalanie papierosem.
- Zastosowanie tworzyw sztucznych z dodatkami zapobiegającymi żółknięciu.
- Ograniczony poziom hałasu.
- Innowacyjne wzornictwo.
- Zatwierdzone przez najważniejsze Instytuty Certyfikujące na całym świecie zgodnie z różnymi normami krajowymi i międzynarodowymi.

CHARACTERISTICS

- Wide range of solutions for all types of installations.
- Possibility of dual flush with the choice of a full or partial flush volume.
- Possibility of pneumatic flush.
- The entire range is supplied with an anti-condensation lining.
- Possibility of low, medium and high position installation.
- Possibility of use with close-coupled pan.
- Specifically designed for public toilets, characterised by cigarette burn resistant lid.
- Use of plastic materials with anti-yellowing additives.
- Limited noise levels.
- Innovative design.
- Approved by the most important Certification Institutes worldwide in compliance with the various national and international standards.

CARACTÉRISTIQUES

- Ample gamme de solutions pour toute typologie d'installation.
- Possibilité de double commande pour le choix d'évacuation totale ou partielle.
- Possibilité de conversion pneumatique.
- Toute la gamme est dotée d'un fourreau anticondensation.
- Possibilité d'installation en position basse, moyenne et haute.
- Possibilité d'association à un WC monobloc.
- Modèle spécifique pour locaux publics, caractérisé par un couvercle antibrûlure de cigarette.
- Utilisation de matières plastiques avec des additifs anti-jaunissement.
- Bruit limité.
- Design novateur.
- Approuvé par les plus importants organismes de certification mondiale en accord avec les différentes normes nationales et internationales.

Mod.	Typ montażu Installation type Typologie installation			Objętość splukiwania Flush volume Volume chasse d'eau			Wersja pneumatyczna Pneumatic version Version pneumatique
							 PNEU
CORALLO3		•		•			•
PERK		•				•	
MIDA		•				•	•
MUREX			•		•		•
ALTANTA	•	•		•		•	+ ZESTAW PNEU
SOLEA	•	•				•	+ ZESTAW PNEU

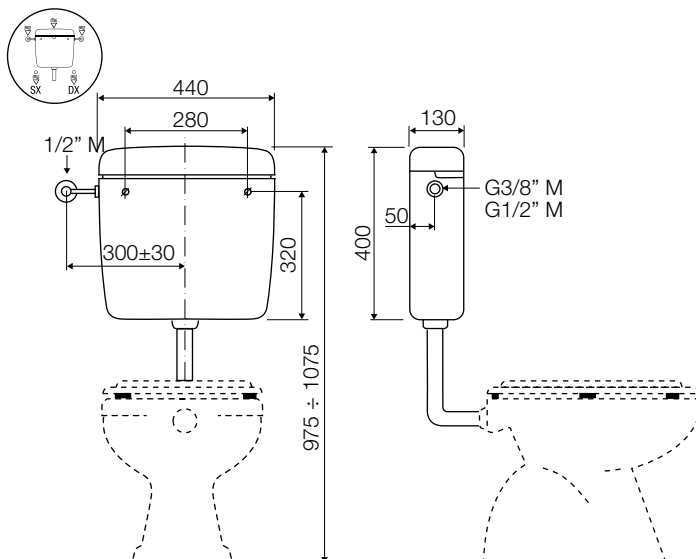

- Typ montażu: niskie położenie
- Objętość spłukiwania: 6/3 l (stand. ustaw.), 9/3 l
- Pojemnik na kostki czyszczące: tak
- Elementy montażowe: dołączone
- Kolor: biały
- Zestaw pneumatycznych wężyków do zdalnej instalacji przycisku: nie dołączony

- Installation type: low potaktion
- Flush volume: 6/3 l (standard setting), 9/3 l
- Receptacle for sanitizing tablet: yes
- Fixing material: included
- Colour: white
- Pneumatic hoses kit for remote installation: not included

- Typologie installation : basse potaktion
- Volume chasse d'eau : 6/3 (pré-réglé), 9/3 l
- Compartiment détergent : oui
- Matériel de fixation : inclus
- Couleur : blanc
- Kit tuyaux pneumatique à distance : non inclus

Mechaniczna - Mechanic - Mécanique

KOD	Splukiwanie Flush Évacuation	Rura Flush pipe Tube	Zawór napełniający Float valve Rob. flotteur	Zawór odcinający dołączony Stop valve included Robinet d'arrêt inclus		CL	pln/szt
VS0816101	podwójne dual - double	tak - yes - oui	3/8"	tak - yes - oui 1/2"	5	SP01	485,54
VS0816103	podwójne dual - double	nie - no	3/8"	nie - no	5	SP01	423,08
VS0816105	podwójne dual - double	tak - yes - oui	1/2"	nie - no	5	SP01	443,92

Pneumatyczna - Pneumatic - Pneumatique

KOD	Splukiwanie Flush Évacuation	Rura Flush pipe Tube	Zawór napełniający Float valve Rob. flotteur	Zawór odcinający dołączony Stop valve included Robinet d'arrêt inclus		CL	pln/szt
VS0816151	pojedyncze takngle - takmple	nie - no	3/8"	nie - no	5	SP01	509,67
VS0816153	podwójne dual - double	nie - no	3/8"	nie - no	5	SP01	578,66

	Szt - Pcs	HxLxP	kg	m ³
1	500x478x150	3,9	0,036	

	Szt - Pcs	HxLxP	kg	m ³
5	520x800x485	19,5	0,21	

	Szt - Pcs	HxLxP	kg	m ³
60	2230x800x1600	242	2,85	

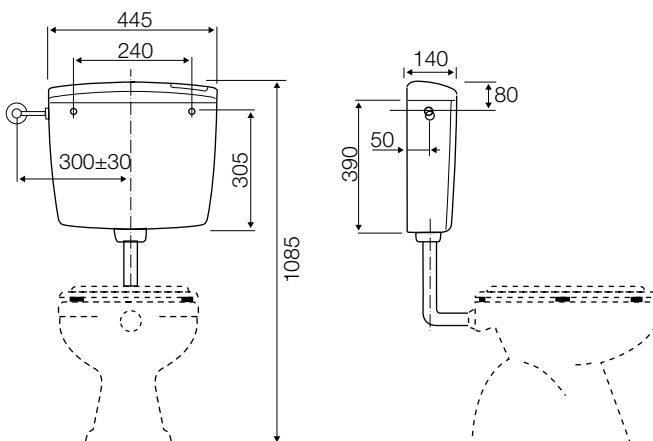



- Typ montażu: niskie położenie
- Objętość spłukiwania: 6 l
- Elementy montażowe: dołączone
- Kolor: biały

- Installation type: low potaction
- Flush volume: 6 l
- Fixing material: included
- Colour: white

- Typologie installation : basse potaction
- Volume chasse d'eau : 6 l
- Matériel de fixation : inclus
- Couleur : blanc

KOD	Spłukiwanie Flush Évacuation	Rura Flush pipe Tube	Zawór odcinający Stop valve Robinet d'arrêt	Podłączenie wody Water inlet Alimentation		CL	pln/szt
VS0846001	6 l + STOP	tak - yes - oui	-	górne - high - haut 3/8"	1	SP01	272,10
VS0846101	6 l + STOP	tak - yes - oui	-	górne - high - haut 1/2"	1	SP01	272,10
VS0847001	6 l + STOP	tak - yes - oui	1/2"	górne - high - haut	1	SP01	312,96

	Szt - Pcs	HxLxP	kg	m ³
1	470x450x150	2,63	0,032	

	Szt - Pcs	HxLxP	kg	m ³
65	2390x800x1200	180	2,30	

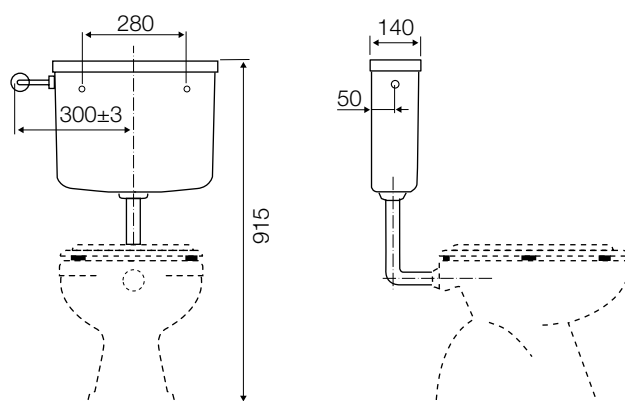

- Typ montażu: niskie położenie
- Objętość spłukiwania: 6 (stand. ustaw.), 9 l
- Elementy montażowe: dołączone
- Kolor: biały
- Zestaw pneumatycznych wężyków do zdalnej instalacji przycisku: nie dołączony

- Installation type: low potaction
- Flush volume: 6 (standard setting), 9 l
- Fixing material: included
- Colour: white
- Pneumatic hoses kit for remote installation: not included

- Typologie installation : basse potaction
- Volume chasse d'eau : 6 (pré-réglé), 9 l
- Matériel de fixation : inclus
- Couleur : blanc
- Kit tuyaux pneumatique à distance : non inclus

Mechaniczna - Mechanic - Mécanique

KOD	Spłukiwanie Flush Évacuation	Rura Flush pipe Tube	Zawór odcinający Stop valve Robinet d'arrêt	Podłączenie wody Water inlet Alimentation		CL	pln/szt
VS0840901	6 l + STOP	tak - yes - oui	1/2"	górne - high - haut	5	SP01	358,47
VS0844001	6 l + STOP	tak - yes - oui	-	górne - high - haut 3/8"	5	SP01	324,79

Pneumatyczna - Pneumatic - Pneumatique

KOD	Spłukiwanie Flush Évacuation	Rura Flush pipe Tube	Zawór odcinający Stop valve Robinet d'arrêt	Podłączenie wody Water inlet Alimentation		CL	pln/szt
VS0842901	6 l	nie - no	-	górne - high - haut 3/8"	5	SP01	439,42

	Szt - Pcs	HxLxP	kg	m ³
	1	500x478x150	3,4	0,036

	Szt - Pcs	HxLxP	kg	m ³
	5	520x800x485	17	0,21

	Szt - Pcs	HxLxP	kg	m ³
	60	2230x800x1600	242	2,85

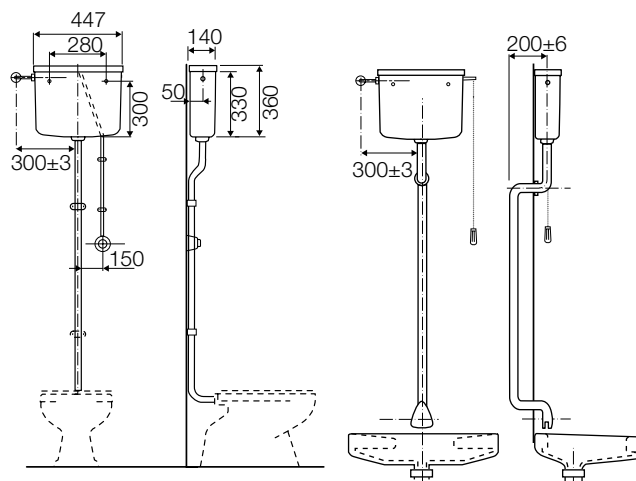

- Typ montażu: wysokie położenie
- Objętość spłukiwania: 6 (stand. ustaw.), 9 l
- Elementy montażowe: dołączone
- Kolor: biały
- Zestaw pneumatycznych wężyków do zdalnej instalacji przycisku: nie dołączony

- Installation type: high potaktion
- Flush volume: 6 (standard setting), 9 l
- Fixing material: included
- Colour: white
- Pneumatic hoses kit for remote installation: not included

- Typologie installation : haute potaktion
- Volume chasse d'eau : 6 (pré-réglé), 9 l
- Matériel de fixation : inclus
- Couleur : blanc
- Kit tuyaux pneumatique à distance : non inclus

Mechaniczna - Mechanic - Mécanique

KOD	Spłukiwanie Flush Évacuation	Rura Flush pipe Tube	Pokrywa Lid Couvercle	Zawór odcinający Stop valve Robinet d'arrêt	Podłączenie wody Water inlet Alimentation		CL	pln/szt
VS0860901	6 l	nie - no	•	-	górne - high - haut 3/8"	5	SP01	323,92
VS0861901	6 l	nie - no	•	1/2"	górne - high - haut	5	SP01	358,47
VS0869001	6 l	nie - no	•	-	górne - high - haut 1/2"	5	SP01	323,92
VS0869101	6 l	nie - no	-	-	górne - high - haut 1/2"	5	SP01	280,46

Pneumatyczna - Pneumatic - Pneumatique

KOD	Spłukiwanie Flush Évacuation	Rura Flush pipe Tube	Pokrywa Lid Couvercle	Zawór odcinający Stop valve Robinet d'arrêt	Podłączenie wody Water inlet Alimentation		CL	pln/szt
VS0862901	6 l	no	•	-	górne - high - haut 3/8"	5	SP01	439,42

	Szt - Pcs	HxLxP	kg	m ³
	1	500x478x150	3,17	0,036

	Szt - Pcs	HxLxP	kg	m ³
	5	520x800x485	16	0,21

	Szt - Pcs	HxLxP	kg	m ³
	60	2230x800x1600	198	2,85

Kompaktowa

Close-coupled - Monobloc

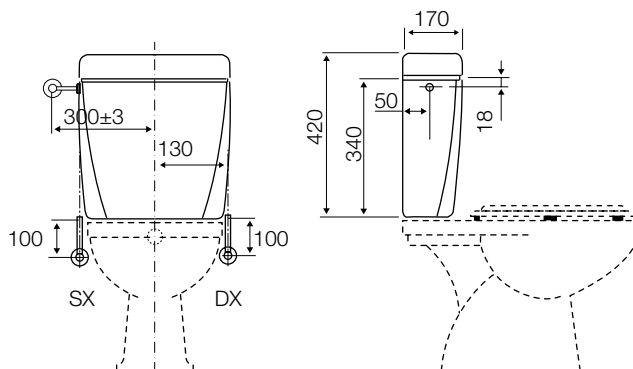

- Typ montażu: kompaktowy
- Objętość spłukiwania: 6/3 (stand. ustaw.), 9/3 l
- Elementy montażowe: dołączone
- Kolor: 01 biały, 05 szary Manhattan
- Zestaw pneumatycznych wężyków do zdalnej instalacji przycisku: nie dołączone

- Installation type: close-coupled
- Flush volume: 6/3 (standard setting), 9/3 l
- Fixing material: included
- Colour: 01 white, 05 Manhattan grey
- Pneumatic hoses kit for remote installation: not included

- Typologie installation : monobloc
- Volume chasse d'eau : 6/3 (pré-réglé), 9/3 l
- Matériel de fixation : inclus
- Couleur : 01 blanc, 05 gris Manhattan
- Kit tuyaux pneumatique à distance : non inclus

Pokrywa delikatna - Violable lid - Couvercle vitaktable

KOD	Splukiwanie Flush Évacuation	Zawór odcinający Stop valve Robinet d'arrêt	Podłączenie wody Water inlet Alimentation		CL	pln/szt
VS0830001	6 l + STOP	1/2"	górne - high - haut	5	SP01	495,92
VS0830005 •	6 l + STOP	1/2"	górne - high - haut	5	SP01	501,23
VS0831701	6 l + STOP	-	dolne - low - faible 3/8"	5	SP01	626,67
VS0830501	6/3 l	1/2"	górne - high - haut	5	SP01	535,65
VS0831901	6/3 l	-	górne - high - haut 3/8"	5	SP01	501,97
VS0831601	6/3 l	-	górne - high - haut 1/2"	5	SP01	501,97

Pokrywa wandaloodporna - Tamper-proof lid - Couvercle inviolable

KOD	Splukiwanie Flush Évacuation	Zawór odcinający Stop valve Robinet d'arrêt	Podłączenie wody Water inlet Alimentation		CL	pln/szt
VS0831101 •	6 l + STOP	-	górne - high - haut 3/8"	5	SP01	505,87

- Wyprzedaż. - Sell out. - Fin de stock.

	Szt - Pcs	HxLxP	kg	m ³
	1	470x424x180	3,9	0,036

	Szt - Pcs	HxLxP	kg	m ³
	5	500x927x445	19,5	0,2

	Szt - Pcs	HxLxP	kg	m ³
	60	2530x800x1200	242	2,43

Niski poziom montaż

Low level installation - Potaktion basse

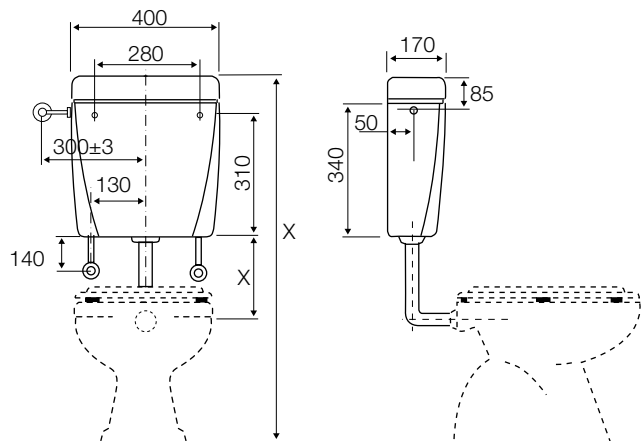



- Typ montażu: niskie położenie
- Objętość spłukiwania: 6/3 (stand. ustaw.), 9/3 l
- Elementy montażowe: dołączone
- Kolor: biały
- Zestaw pneumatycznych wężyków do zdalnej instalacji przycisku: nie dołączony

- Installation type: low potaktion
- Flush volume: 6/3 (standard setting), 9/3 l
- Fixing material: included
- Colour: white
- Pneumatic hoses kit for remote installation: not included

- Typologie installation : basse potaktion
- Volume chasse d'eau : 6/3 (pré-réglé), 9/3 l
- Matériel de fixation : inclus
- Couleur : blanc
- Kit tuyaux pneumatique à distance : non inclus

KOD	Spłukiwanie Flush Évacuation	Rura Flush pipe Tube	Zawór odcinający Stop valve Robinet d'arrêt	Podłączenie wody Water inlet Alimentation		CL	pln/szt
VS0835001	6 l + STOP	tak - yes - oui	1/2"	górne - high - haut	5	SP01	522,60
VS0835301	6 l + STOP	nie - no	-	dolne - low - faible 3/8"	5	SP01	627,63
VS0835901	6/3 l	tak - yes - oui	1/2"	górne - high - haut	5	SP01	560,84
VS0837601	6/3 l	tak - yes - oui	-	górne - high - haut 3/8"	5	SP01	527,20
VS0837501	6/3 l	tak - yes - oui	-	górne - high - haut 1/2"	5	SP01	527,20

	Szt - Pcs	HxLxP	kg	m ³
	1	470x424x180	4,1	0,036

	Szt - Pcs	HxLxP	kg	m ³
	5	500x927x445	20	0,2

	Szt - Pcs	HxLxP	kg	m ³
	60	2530x800x1200	254	2,43

Kompaktowa

Close-coupled - Monobloc

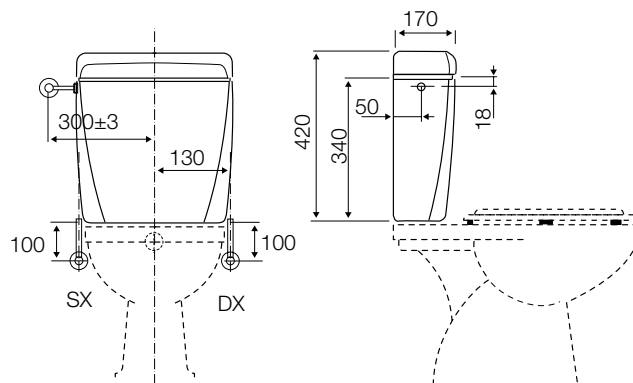

- Typ montażu: kompaktowy
- Objętość spłukiwania: 6 (stand. ustaw.), 9 l
- Elementy montażowe: dołączone
- Kolor: biały
- Zestaw pneumatycznych wężyków do zdalnej instalacji przycisku: nie dołączony

- Installation type: close-coupled
- Flush volume: 6 (standard setting), 9 l
- Fixing material: included
- Colour: white
- Pneumatic hoses kit for remote installation: not included

- Typologie installation : monobloc
- Volume chasse d'eau : 6 (pré-réglé), 9 l
- Matériel de fixation : inclus
- Couleur : blanc
- Kit tuyaux pneumatique à distance : non inclus

Pokrywa delikatna - Violable lid - Couvercle vitaktable

KOD	Spłukiwanie Flush Évacuation	Zawór odcinający Stop valve Robinet d'arrêt	Podłączenie wody Water inlet Alimentation		CL	pln/szt
VS0834901	6 l + STOP	1/2"	górne - high - haut	5	SP01	495,92
VS0834001	6 l + STOP	-	górne - high - haut 1/2"	5	SP01	462,24

	Szt - Pcs	HxLxP	kg	m ³
	1	470x424x180	3,8	0,036

	Szt - Pcs	HxLxP	kg	m ³
	5	500x924x445	19	0,2

	Szt - Pcs	HxLxP	kg	m ³
	60	2530x800x1200	236	2,43

Niski poziom montażu

Low level installation - Potaktion basse

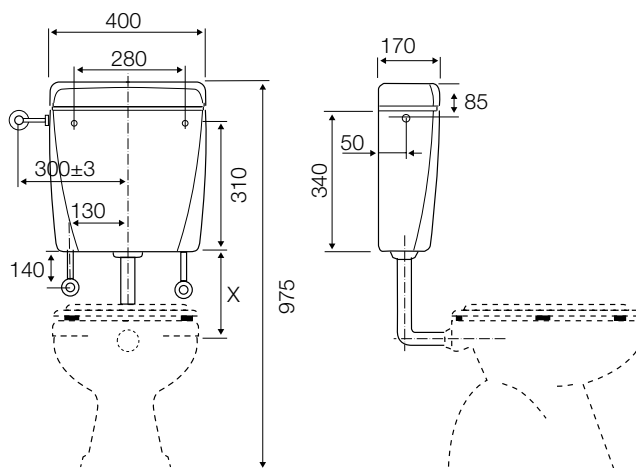

- Typ montażu: niske położenie
- Objętość spłukiwania: 6 (stand. ustaw.), 9 l
- Elementy montażowe: dołączone
- Kolor: biały
- Zestaw pneumatycznych wężyków do zdalnej instalacji przycisku: nie dołączony

- Installation type: low potaktion
- Flush volume: 6 (standard setting), 9 l
- Fixing material: included
- Colour: white
- Pneumatic hoses kit for remote installation: not included

- Typologie installation : basse potaktion
- Volume chasse d'eau : 6 (pré-réglé), 9 l
- Matériel de fixation : inclus
- Couleur : blanc
- Kit tuyaux pneumatique à distance : non inclus

KOD	Spłukiwanie Flush Evacuation	Rura Flush pipe Tube	Zawór odcinający Stop valve Robinet d'arrêt	Podłączenie wody Water inlet Alimentation		CL	pln/szt
VS0834501 •	6 l + STOP	tak - yes - oui	1/2"	górne - high - haut	5	SP01	459,10
VS0833701 •	6 l + STOP	nie - no	1/2"	górne - high - haut	5	SP01	584,64

- Wyprzedaż. - Sell out. - Fin de stock.

	Szt - Pcs	HxLxP	kg	m ³
	1	470x424x180	4,1	0,036

	Szt - Pcs	HxLxP	kg	m ³
	5	500x924x445	20,5	0,2

	Szt - Pcs	HxLxP	kg	m ³
	60	2530x800x1200	254	2,43

AKCESORIA DO SPŁUCZEK NADTYNKOWYCH

ACCESSORIES FOR EXPOSED FLUSH CISTERNS

ACCESSOIRES POUR RÉSERVOIRS APPARENTS

Rura spustowa \varnothing_{IN} 50

Flush pipe \varnothing_{IN} 50

Tube d'évacuation \varnothing_{IN} 50

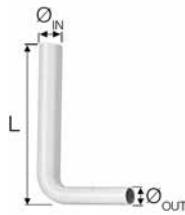

KOD	\varnothing_{OUT}	L	Kolor - Colour - Couleur		CL	pln/szt
VS0815201	44	230	biały - white - blanc	1	VA02	38,76
VS0815203 •	44	230	szampański - champagne	1	VA02	38,59
VS0815001	32	325	biały - white - blanc	1	VA02	50,79
VS0815035 •	32	325	chrom połysk - polished chrome - chromé brillant	1	VA02	76,65
VS0815101	40	325	biały - white - blanc	1	VA02	40,62
VS0815103 •	40	325	szampański - champagne	1	VA02	40,05
VS0815105 •	40	325	szary manhattan - manhattan grey - gris manhattan	1	VA02	40,05
VS0815301	32	600	biały - white - blanc	1	VA02	83,63
VS0815313 •	32	600	blady różowy - pale pink - rose pastel	1	VA02	80,23
VS0815317 •	32	600	beżowy - beige - vison beige	1	VA02	80,23
VS0815401	32	1000	biały - white - blanc	1	VA02	111,62
VS0815405 •	32	1000	szary manhattan - manhattan grey - gris manhattan	1	VA02	109,41
VS0815409 •	32	1000	jasnoniebieski - pale blue - bleu azur	1	VA02	109,41
VS0815417 •	32	1000	beżowy - beige - vison beige	1	VA02	109,41
VS0815421 •	32	1000	pergamon	1	VA02	109,41

• Wypredaż. - Sell out. - Fin de stock.

Segmentowa, wydłużona rura spustowa \varnothing 50/32 L 980

Sectional, extended flush
pipe \varnothing 50/32 - length 980

Tube d'évacuation rallongé
réglable \varnothing 50/32 L 980



KOD	Kolor - Colour - Couleur		CL	pln/szt
VS0815501	biały - white - blanc	1	VA02	127,08

Części zamienne - Spare parts - Pièces de rechange

Zestaw z mufą połączeniową i elementami montażowymi do segmentowych rur dla wysokiego montażu spłuczek

Kit with connection sleeve and fastening material for sectional pipes used with high-level cisterns

Kit complet de manchon de liaison et accessoires de fixation pour tubes pour réservoir de chasse haute



KOD	Kolor - Colour - Couleur		CL	pln/szt
VS0817001	biały - white - blanc	1	VA02	35,67
VS0817003 •	szampański - champagne	1	VA02	32,85

• Wyprzedaż. - Sell out. - Fin de stock.

Rura spustowa Ø 50/32
L 1000 o małych wymiarach

Space-saving flush pipe Ø 50/32 - length 1000

Tube d'évacuation Ø 50/32
L 1000 faible encombrement



KOD	Kolor - Colour - Couleur		CL	pln/szt
VS0815601	biały - white - blanc	1	VA02	111,62
VS0815603 •	szampański - champagne	1	VA02	109,41

• Wyprzedaż. - Sell out. - Fin de stock.

Segmentowa, nadtynkowa rura spustowa Ø 32 z ABS do spłuczki Murex

Sectional, external ABS flush pipe Ø 32 for Murex cistern

Tube d'évacuation réglable externe Ø 32 pour réservoir Murex



KOD	D	H	Kolor - Colour - Couleur		CL	pln/szt
VS0815071	32	2000	biały - white - blanc	1	VA02	167,93

Akcesoria - Akcesoriaes - Accessoires

Manszet gumowy do miski WC

Key-seal for toilets

Joint pour cuvette



KOD	D		CL	pln/szt
VS0816001	32	10	VA02	14,19
VS0816003	40	10	VA02	14,19
VS0816005	44	10	VA02	14,19

Rura spustowa do montażu podtynkowego Ø 56/40, z manszetem gumowym Ø 40

Flush pipe for concealed installation Ø 56/40, with rubber adaptor Ø 40

Tube d'évacuation derrière cloison Ø 56/40, avec joint Ø 40



KOD		CL	pln/szt
VS0815999	1	VA02	108,83

Części zamienne - Spare parts - Pièces de rechange

Manszet gumowy do rury spustowej

Key-seal for flush pipe

Étau pour tuyau de rinçage



KOD		CL	pln/szt
VS0802016	10	SP02	11,88

Dwuczęściowa
rura spłukująca z
PP i HDPE Ø 32

PP and HDPE 2-piece
flush pipe Ø 32

Tube de chasse en deux
parties en PP et HDPE Ø 32

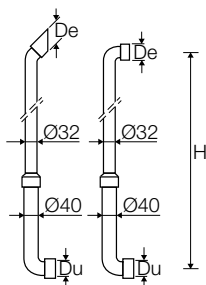

KOD	De-Du	α	H max		CL	pln/szt
VS0700098	32	45° PP	1600	50	VA02	96,58
VS0700099	32	90° PP	1600	50	VA02	96,58
VS0335001	32	45° HDPE	1765	20	VA02	160,72
VS0335003	32	90° HDPE	1765	20	VA02	143,97

Części zamienne - Spare parts - Pièces de rechange

Uszczelka jednowargowa PP

PP 1-lip seal

Joint à une lèvre PP



KOD	Ø		CL	pln/szt
VS0391320	32	20	VA02	3,94

Dla kodów - For codes - Pour réf. VS0700098 - VS0700099.

Manszet gumowy do
kolan 45° HDPE

Grommet for 45° HDPE elbow

Étau pour évacuation 45° HDPE

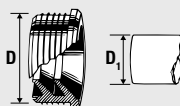

KOD	Ø		CL	pln/szt
VS0334021	40	50	PE02	4,93

Dla kodów - For codes - Pour réf. VS0335001 - VS0335003.

Akcesoria - Akcesoriaes - Accessoires

Manszet gumowy do miski WC

Key-seal for toilets

Joint pour cuvette



KOD	D		CL	pln/szt
VS0816001	32	10	VA02	14,19
VS0816003	40	10	VA02	14,19
VS0816005	44	10	VA02	14,19

**Dyfuzor do toalet tureckich
do rury spustowej Ø 32**Spreader for squatting pan
for Ø 32 flush pipesQueue de carpe pour
WC à la turque Ø 32

KOD	Kolor - Colour - Couleur		CL	pln/szt
VS0815083	biały - white - blanc	5	VA02	60,56

**Rura spustowa z kolanem
Ø 32-90° do wysokiego
montażu spłuczek, z rozetą**Flush pipe Ø 32-90°
for high-level cistern,
complete with flangeCoude d'évacuation Ø 32-90°
pour raccord du réservoir de
chasse haute, avec rosace

KOD	Kolor - Colour - Couleur		CL	pln/szt
VS0815801	biały - white - blanc	1	VA02	52,12

Dla kodów - For codes - Pour réf. VS0700099.

**Mosiężna rura spustowa
z kolanem Ø 32-45° do
wysokiego montażu
spłuczek, z rozetą**Brass flush bend Ø 32-45° for
high-level cistern, with flangeCoude d'évacuation Ø 32-45°
en laiton chromé pour réservoir
de chasse haute, avec rosace

KOD	Kolor - Colour - Couleur		CL	pln/szt
VS0815064	chrom połysk - polished chrome - chromé brillant	1	VA02	87,08

Dla kodów - For codes - Pour réf. VS0700098-VS0335001

Części zamienne - Spare parts - Pièces de rechange

Rozeta z chromowanego ABS do rur spustowych Ø 32-45°

ABS chrome-plated flange
Ø 32-45° for flush pipes

Rosace pour tubes de chasse
ABS chromé Ø 32-45°



KOD	Kolor - Colour - Couleur		CL	pln/szt
VS0337001	chrom połysk - polished chrome - chromé brillant	20	VA02	35,94

Zestaw akcesoriów: śruby, podkładki i elementy mocujące do ściany dla spłuczek nadtynkowych

Aksesoriaes kit with screw,
fasteners and fixing elements
for wall exposed cisterns

Kit accessoires, vis ,chevilles,
éléments de fixation pour
mur réservoirs apparents



KOD		CL	pln/szt
VS0810115	1	VA02	45,88

Zestaw zawiera 2 śruby, 2 podkładki i 2 elementy mocujące. - The kit include 2 screws, 2 fasteners and 2 fixing elements. - Le kit contient deux vis, 2 chevilles et 2 éléments de fixation.

Zestaw akcesoriów: śruby, podkładki i elementy mocujące dla spłuczek kompaktowych Atlanta, Solea i Island

Aksesoriaes kit with screw,
fasteners and fixing elements
for cisterns close-coupled
Atlanta, Solea and Island

Kit accessoires, vis,
chevilles, éléments de
fixation pour Atlanta, Solea
et Island monobloc



KOD		CL	pln/szt
VS0822015	1	VA02	51,14

Zestaw zawiera 2 śruby, 2 podkładki i 2 elementy mocujące. - The kit include 2 screws, 2 fasteners and 2 fixing elements. - Le kit contient deux vis, 2 chevilles et 2 éléments de fixation.

Zestaw wężyków
przyłączeniowych
do mechanizmów
pneumatycznych,
pojedyncze
spłukiwanie, 2,5 m

Connection pipes for pneumatic
mechanism, single flush, 2.5 m

Kit tube de raccordement
pneumatique évacuation
totale 2,5 m



KOD		CL	pln/szt
VS0872204 *	1	VA02	83,02

* Do zdalnej instalacji przycisku. - For remote control applications. - eusement pour applications à commande à distance (actionnement à distance).

Zestaw wężyków
przyłączeniowych
do mechanizmów
pneumatycznych,
podwójne
spłukiwanie, 2,5 m

Connection pipes for pneumatic
mechanism, dual flush, 2.5 m

Kit tubes de raccordement
pneumatiques 2 quantités 2,5 m



KOD		CL	pln/szt
VS0872206 *	1	VA02	135,66

* Do zdalnej instalacji przycisku. - For remote control applications. - eusement pour applications à commande à distance (actionnement à distance).

ATLANTA2 - SOLEA
Zawór odcinający z
zestawem instalacyjnym,
dolne podłączenie wody,
z prawej-lewej strony

Valve kit for inlet from
below, right-left side

Raccordement par le bas droit-
gauche avec kit robinet d'arrêt

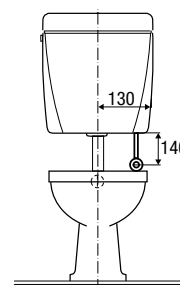

KOD		CL	pln/szt
VS0810114	1	VA02	108,56

ATLANTA2 - ISLAND2
Zawór odcinający z
zestawem instalacyjnym,
tylne podłączenie wody
Inlet valve kit - rear connection
Raccordement arrière
avec kit robinet d'arrêt

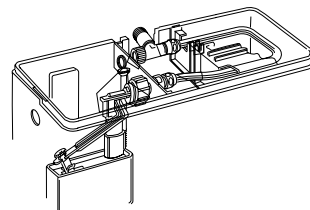

KOD		CL	pln/szt
VS0810181 •	1	VA02	131,42

• Wyprzedaż. - Sell out. - Fin de stock.

MIDA - MUREX
Zawór odcinający z
zestawem instalacyjnym,
tylne podłączenie wody
Inlet valve kit - rear connection
Raccordement arrière
avec kit robinet d'arrêt

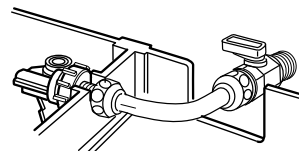

KOD			CL	pln/szt
VS0810199	G 3/8"x10	1	VA02	125,54
VS0810998	G 1/2"x10	1	VA02	125,54

CZĘŚCI ZAMIENNE

SPARE PARTS - PIÈCES DE RECHANGE

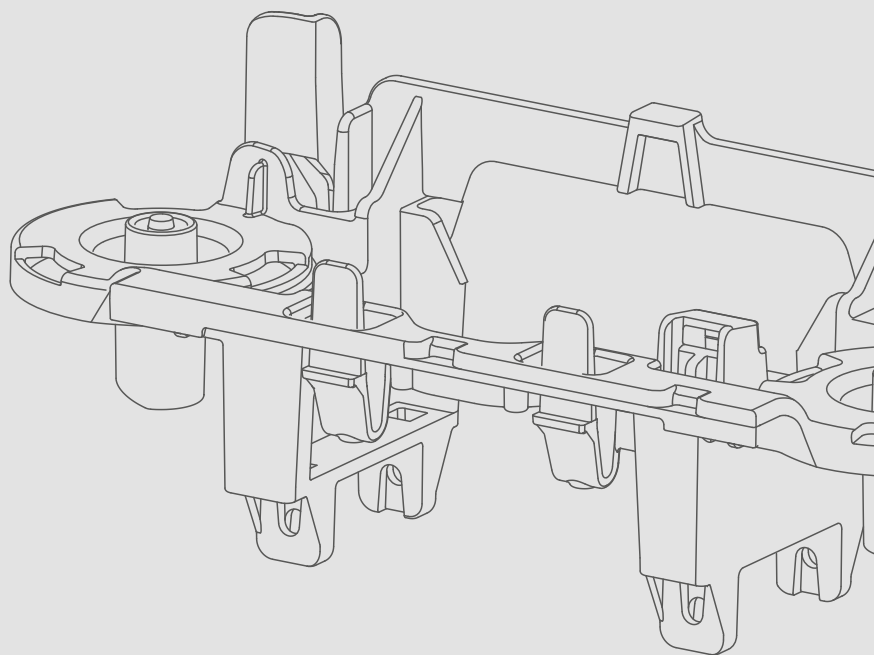
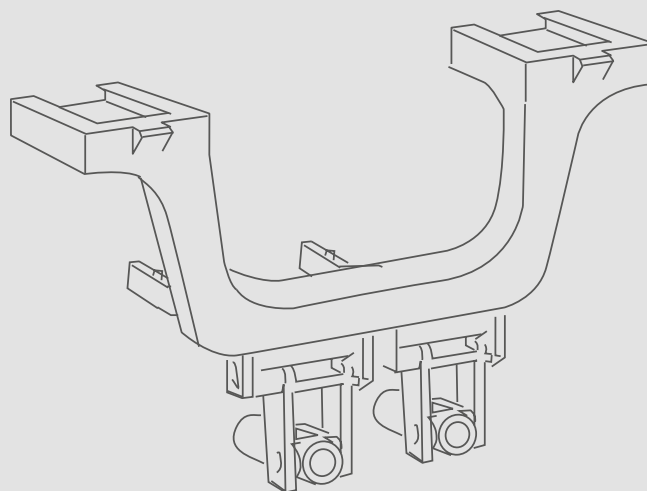
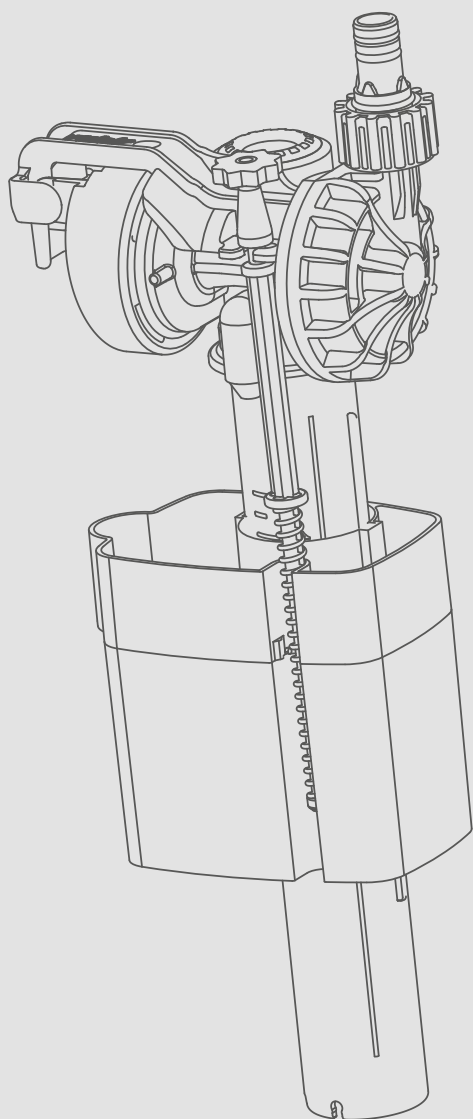







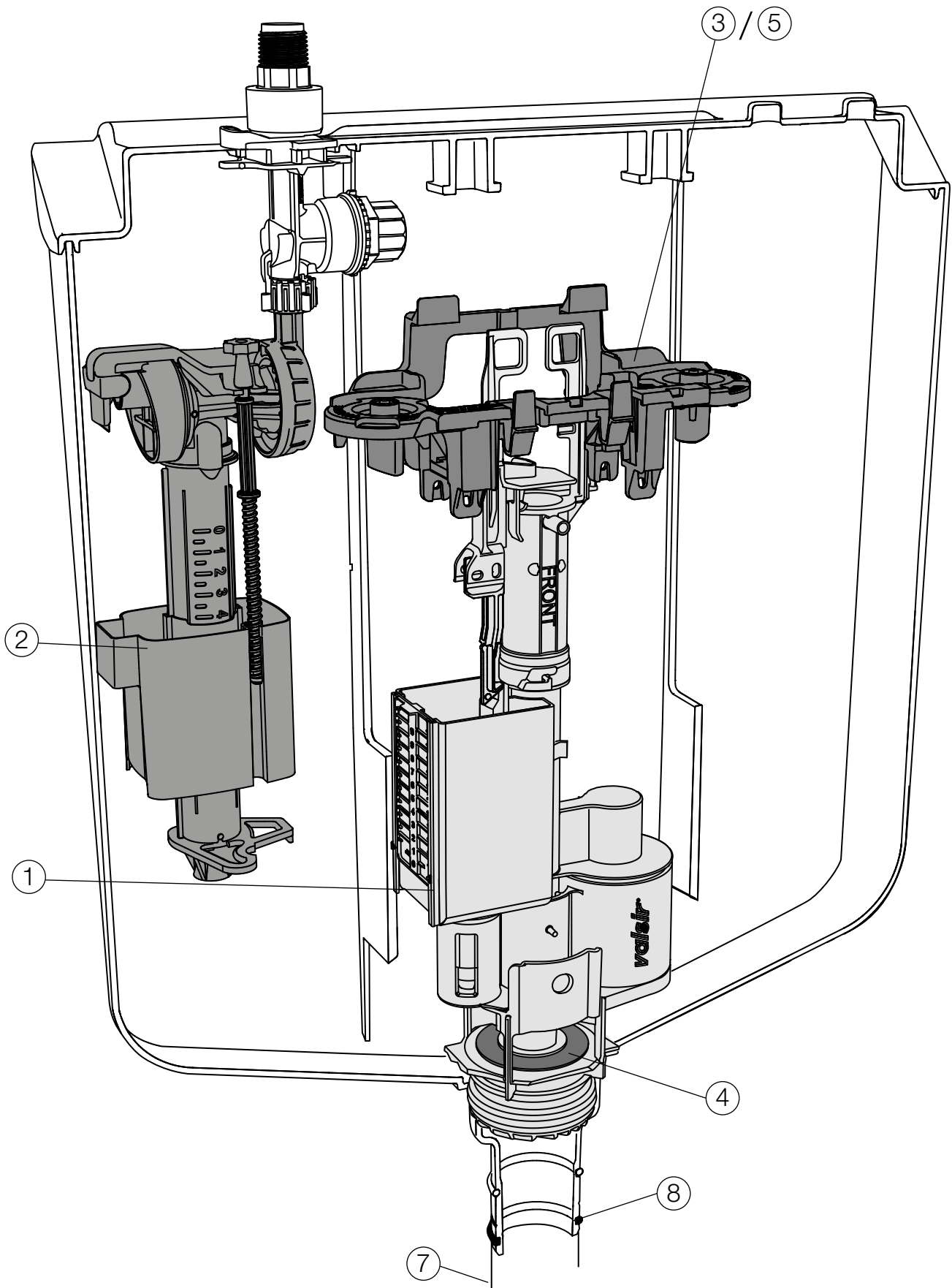

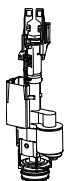
CZĘŚCI ZAMIENNE: GWARANCJĄ NA PRZYSZŁOŚĆ

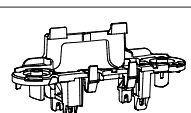

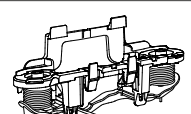
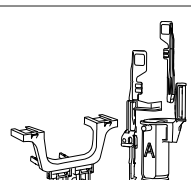
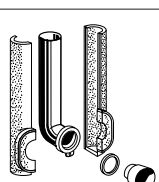

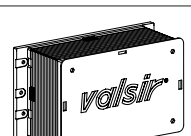

SPARE PARTS: THE GUARANTEE FOR THE FUTURE

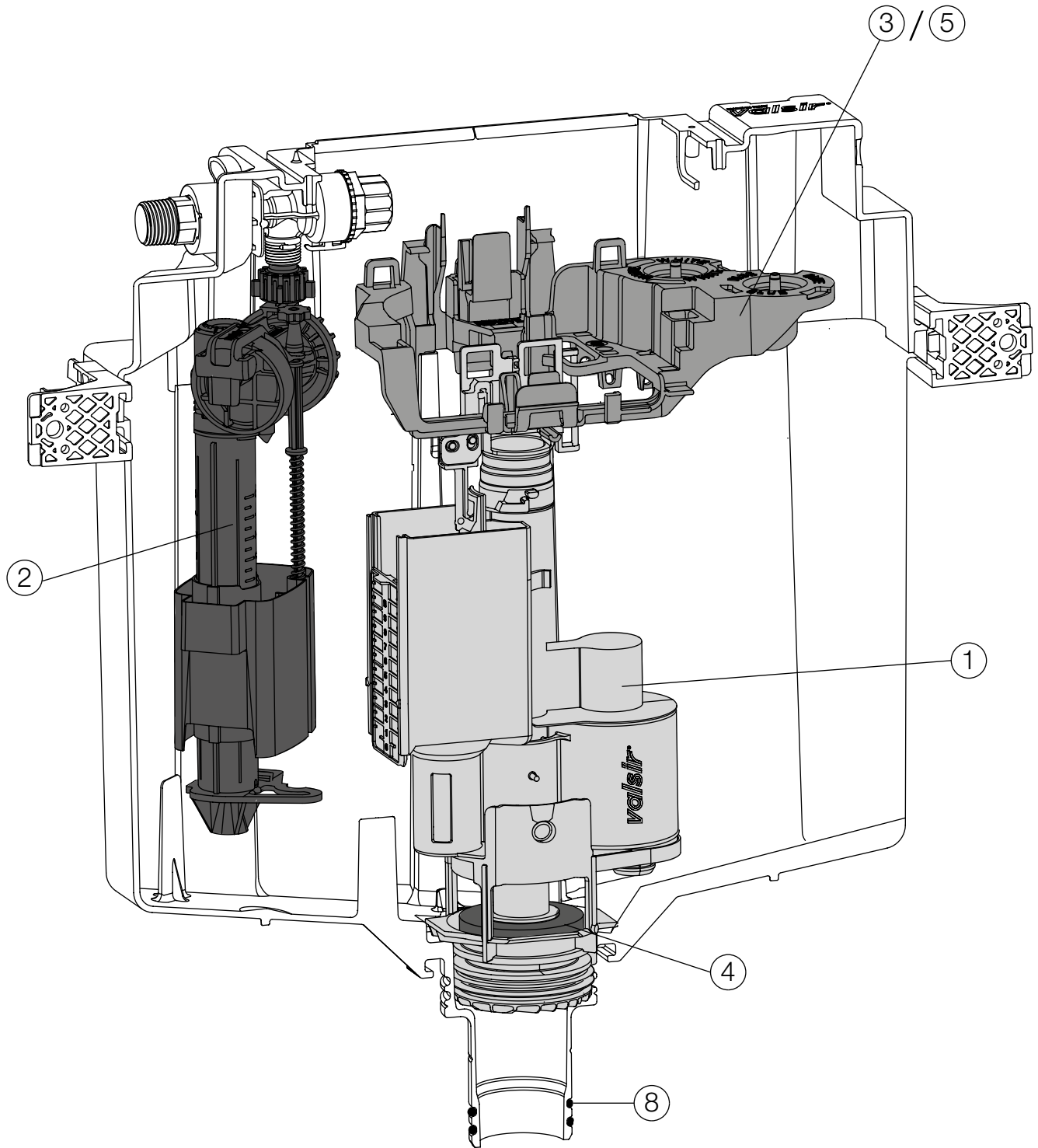
PIÈCES DE RECHANGE : LA GARANTIE POUR LE FUTUR

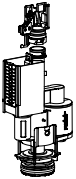
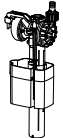
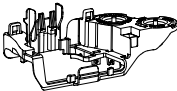
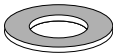
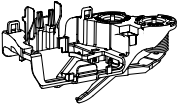
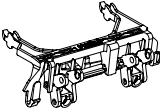







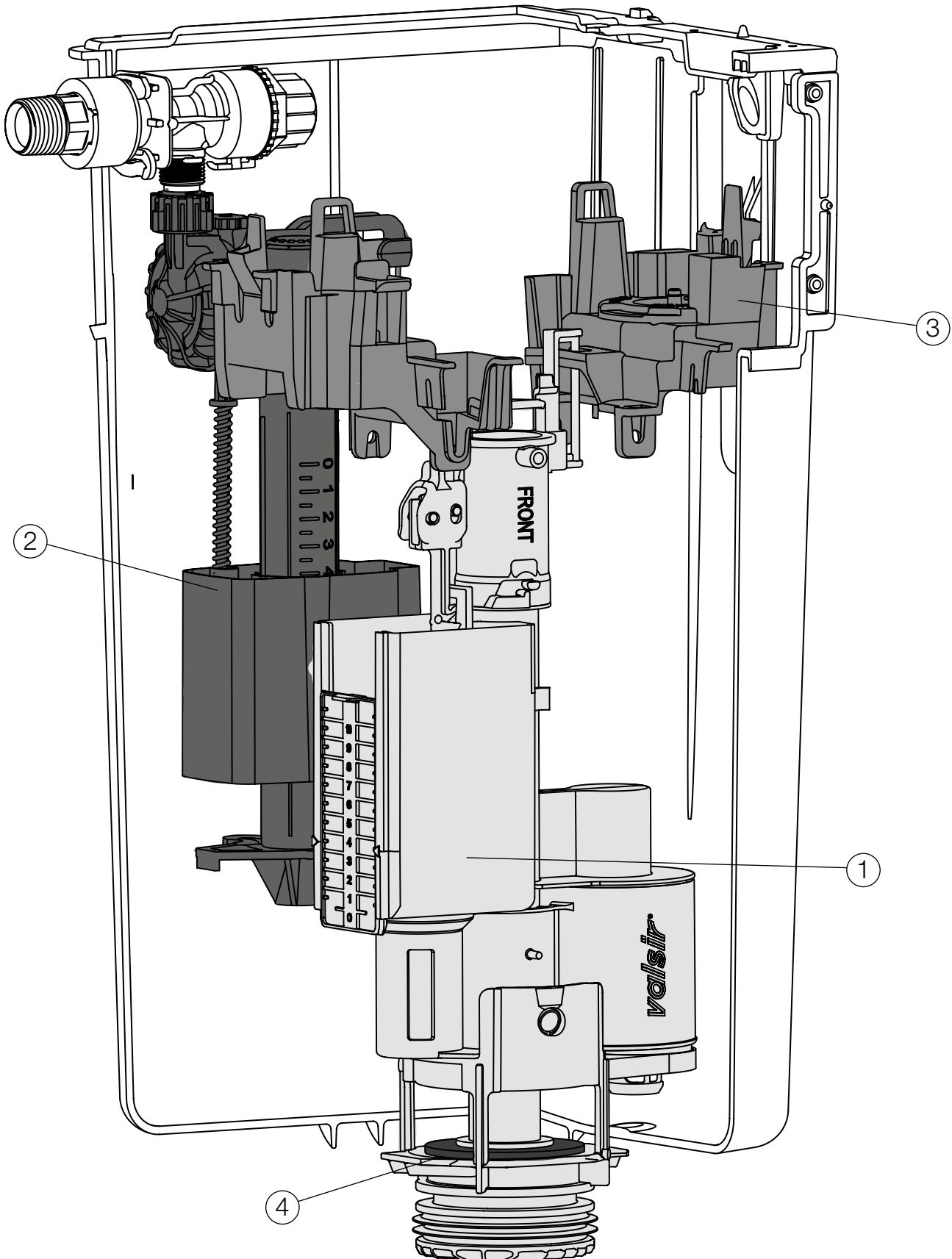

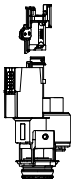

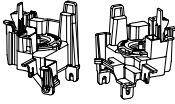
Części zamienne - Spare parts - Pièces de rechange		KOD		CL	pln/szt	
①		Tropea S/Tropea3 mechaniczny zawór opróżniający Tropea S/Tropea3 mechanical valve Vanne pour Tropea S/Tropea 3 mécanique	VS0866690	1	SP02	147,03
②		Zawór napełniający Compact float valve Robinet flotteur Compact	VS0866693	1	SP02	121,61
③		Blokada centralna Tropea S Tropea S central block Bloc central reservoir Tropea S	VS0866794	1	SP02	32,39
④		Uszczelka zaworu opróżniającego Seal for outlet valve Joint de mécanisme	VS0866603	10	SP02	10,24
⑤		Zestaw modyfikujący model mechaniczny na pneumatyczny Tropea S Tropea S mechanical to pneumatic conversion kit Kit de commutation de mécanique à pneumatique Tropea S	VS0866792	1	SP02	172,93
⑥		Zestaw modyfikujący model pneumatyczny na mechaniczny Pneumatic to mechanical conversion kit Kit de commutation de pneumatique à mécanique	VS0866696	1	SP02	69,60
⑦		Zestaw z rurą spustową Tropea S/Tropea3 Flush pipe kit for Tropea S/Tropea3 Kit tuyau de rinçage pour Tropea S/Tropea3	VS0866580	1	SP02	73,36
⑧		O-ring do rury spustowej (2 szt) O-ring for connection pipe (2 pcs) Joint torique pour embout (2 pcs)	VS0820163	1	SP02	13,47
⑨		Uszczelka 2-wargowa do rury spustowej 2-lip seal for flush pipe Joint en deux lèvres pour tuyau de chasse	VS0820119	1	SP02	7,76
⑩		Skrzynka ochronna Protective case Boîtier de protection	VS0866625	1	SP02	91,45
⑪		Zawór odcinający Stop valve Robinet d'arrêt	VS0866735	1	SP02	79,74

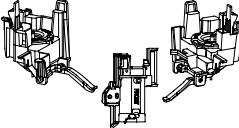
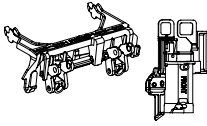

Części zamienne - Spare parts - Pièces de rechange			KOD		CL	pln/szt
①		Winner S mechaniczny zawór opróżniający Winner S mechanical valve Vanne pour Winner S mécanique	VS0866790	1	SP02	147,03
②		Zawór napełniający Compact float valve Robinet flotteur Compact	VS0866693	1	SP02	121,61
③		Blokada centralna Winner S Winner S central block Bloc central reservoir Winner S	VS0866994	1	SP02	39,22
④		Uszczelka zaworu opróżniającego Seal for outlet valve Joint de mécanisme	VS0866603	10	SP02	10,24
⑤		Zestaw modyfikujący model mechaniczny na pneumatyczny Winner S Winner S mechanical to pneumatic conversion kit Kit de commutation de mécanique à pneumatique Winner S	VS0866992	1	SP02	172,93
⑥		Zestaw modyfikujący model pneumatyczny na mechaniczny Pneumatic to mechanical conversion kit Kit de commutation de pneumatique à mécanique	VS0866796	1	SP02	57,79
⑧		O-ring do rury spustowej (2 szt) O-ring for connection pipe (2 pcs) Joint torique pour embout (2 pcs)	VS0820163	1	SP02	13,47
⑨		Uszczelka 2-wargowa do rury spustowej 2-lip seal for flush pipe Joint en deux lèvres pour tuyau de chasse	VS0820119	1	SP02	7,76
⑩		Skrzynka ochronna Protective case Boîtier de protection	VS0866625	1	SP02	91,45
⑪		Zestaw z rurą spustową dla Winner S H 800/820/880 Flush pipe kit for Winner S H 800/820/880 Kit tuyau de rinçage pour Winner S H 800/820/880	VS0863509	1	SP02	53,81
⑫		Zestaw z rurą spustową dla Winner S H 1050/1140 Flush pipe kit for Winner S H 1050/1140 Kit tuyau de rinçage pour Winner S H 1050/1140	VS0868284	1	SP02	49,22
⑬		Zawór odcinający Stop valve Robinet d'arrêt	VS0863540	1	SP02	107,16

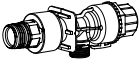

Części zamienne - Spare parts - Pièces de rechange		KOD		CL	pln/szt	
①		Cubik S mechaniczny zawór opróżniający Cubik S mechanical valve Vanne pour Cubik S mécanique	VS0866890	1	SP02	147,03
②		Zawór napełniający Compact float valve Robinet flotteur Compact	VS0866693	1	SP02	121,61
③		Blokada centralna Cubik S Cubik S central block Bloc central reservoir Cubik S	VS0866894	1	SP02	52,77
④		Uszczelka zaworu opróżniającego Seal for outlet valve Joint de mécanisme	VS0866603	10	SP02	10,24
⑤		Zestaw modyfikujący model mechaniczny na pneumatyczny Cubik S Cubik S mechanical to pneumatic conversion kit Kit de commutation de mécanique à pneumatique Cubik S	VS0866892	1	SP02	190,52
⑥		Zestaw modyfikujący model pneumatyczny na mechaniczny Pneumatic to mechanical conversion kit Kit de commutation de pneumatique à mécanique	VS0866896	1	SP02	100,01
⑧		O-ring do rury spustowej (2 szt) O-ring for connection pipe (2 pcs) Joint torique pour embout (2 pcs)	VS0820163	1	SP02	13,47
⑨		Uszczelka 2-wargowa do rury spustowej 2-lip seal for flush pipe Joint en deux lèvres pour tuyau de chasse	VS0820119	1	SP02	7,76
⑨		Skrzynka ochronna Protective case Boîtier de protection	VS0866625	1	SP02	91,45
⑩		Zestaw z rurą spustową dla Cubik S H 880 Flush pipe kit for Cubik S H 880 Kit tuyau de rinçage pour Cubik S H 880	VS0863565	1	SP02	74,33
⑪		Zestaw z rurą spustową dla Cubik S H 1060 Flush pipe kit for Cubik S H 1060 Kit tuyau de rinçage pour Cubik S H 1060	VS0868284	1	SP02	49,22
⑫		Zawór odcinający Stop valve Robinet d'arrêt	VS0863540	1	SP02	107,16

CZĘŚCI ZAMIENNE DO SYSTEMU ARIAPUR

ARIAPUR SYSTEM SPARE PARTS

PIÈCES DE RECHANGE ARIAPUR

Obudowa
wentylatora
Ariapur80 i
Ariapur100Led

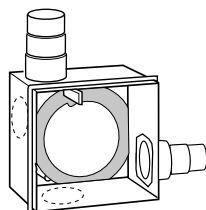

KOD		CL	pln/szt
VS0874203	1	SP02	475,67

Panel czołowy
Ariapur80 i
Ariapur100Led

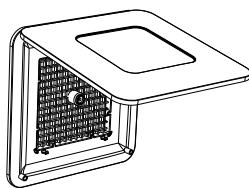

KOD	Mod.		CL	pln/szt
VS0874211	ARIAPUR80	1	SP02	390,55
VS0874212	ARIAPUR100LED	1	SP02	941,32

Wentylator
Ariapur80 i
Ariapur100Led

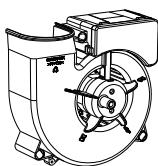

KOD	Mod.		CL	pln/szt
VS0874215	ARIAPUR80	1	SP02	1 264,27
VS0874216	ARIAPUR100LED	1	SP02	1 952,74

Filtr
Ariapur80 i
Ariapur100Led

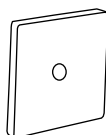

KOD		CL	pln/szt
VS0874220	5	SP02	117,67

Zestaw z dwoma uchwytemi
i śrubami do mocowania
skrzynki wentylatora do ścian

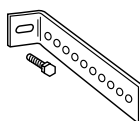

KOD		CL	pln/szt
VS0874012	1	SP02	113,04

Dystans do ścian
murowanych od 80 do
105 mm (Ariapur
produkowany do 2018)

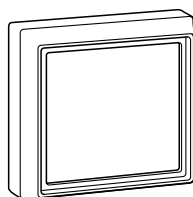

KOD		CL	pln/szt
VS0874011	1	SP02	151,59

Obudowa wentylatora
(Ariapur produkowany
do 2018)

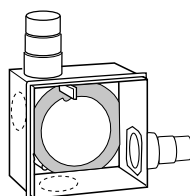

KOD		CL	pln/szt
VS0874013	1	SP02	707,53

Panel czołowy z filtrem
(Ariapur produkowany
do 2018)

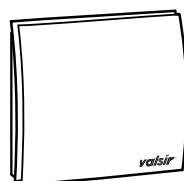

KOD		CL	pln/szt
VS0874015	1	SP02	239,20

Wentylator Ariapur
(Ariapur produkowany
do 2018)

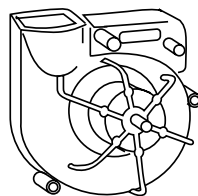

KOD		CL	pln/szt
VS0874016	1	SP02	2 2374,76

Rura spustowa
do połączenia z
systemem Ariapur

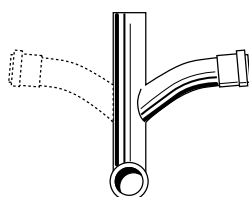

KOD	Mod.		CL	pln/szt
VS0866640	Tropea S, Winner S, Tropea3	1	SP02	215,82
VS0874022	Winner 2	1	SP02	165,23

CZĘŚCI ZAMIENNE DO PRZYCISKÓW

PUSH PLATES SPARE PARTS

PIÈCES DE RECHANGE PLAQUES

P1-P2 MEC

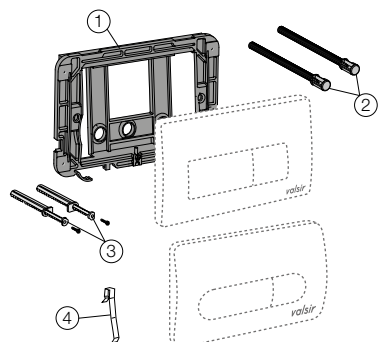

		KOD		CL	pln/szt
①	Ramka montażowa ze śrubami i dystansami Plate support frame complete with screws and spacers Contreplaque, vis et entretoises	VS0871348	1	SP02	76,42
②	Popychacze opróżniania Screws for control mechanisms Vis d'actionnement	VS0866695	1	SP02	16,14
③	Dystanse do montażu ramki przycisku Spacer for attaching plate Entretoises de fixation plaque	VS0864166	1	SP02	18,42
④	Sprężyna Spring Ressort	VS0822127	1	SP02	9,07

P1-P2 PNEU

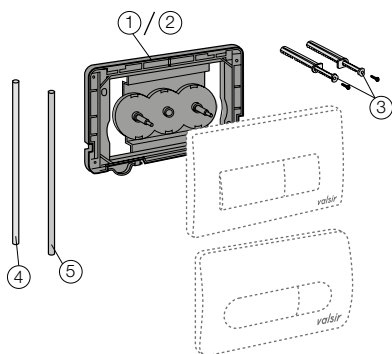

		KOD		CL	pln/szt
①	Ramka montażowa z dystansami i wężykami PVC od 2004 do 2012 Plate support frame complete with spacer and PVC pipes from 2004 to 2012 Contreplaque, entretoises et tuyaux PVC de 2004 à 2012	VS0871548	1	SP02	149,74
②	Ramka montażowa z dystansami i wężykami PVC od 2013 Plate support frame complete with spacer and PVC pipes from 2013 Contreplaque, entretoises et tuyaux PVC de 2013	VS0871549	1	SP02	149,74
③	Dystanse do montażu ramki przycisku Spacer for attaching plate Entretoises de fixation plaque	VS0864166	1	SP02	18,42
④	Wężyk PVC biały Ø 6x4 - 360 mm White PVC pipe Ø 6x4 - 360 mm Tube PVC blanc Ø 6x4 - 360 mm	VS0804697	1	SP02	9,46
⑤	Wężyk PVC niebieski Ø 6x4 - 360 mm Blue PVC pipe Ø 6x4 - 360 mm Tube PVC bleu Ø 6x4 - 360 mm	VS0804698	1	SP02	9,46

P3-P4-P5 MEC

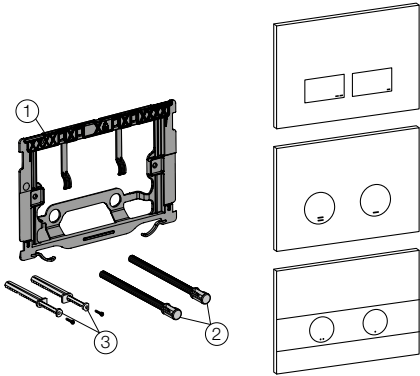
		KOD		CL	pln/szt
	①	Kompletna ramka montażowa Plate support frame complete Kit conteplaque	VS0871349	1	SP02 76,42
	②	Popychacze opróżniania Screws for control mechanisms Vis d'actionnement	VS0866695	1	SP02 16,14
	③	Dystanse do montażu ramki przycisku Spacer for attaching plate Entretoises de fixation plaque	VS0864166	1	SP02 18,42

P3-P4-P5 PNEU

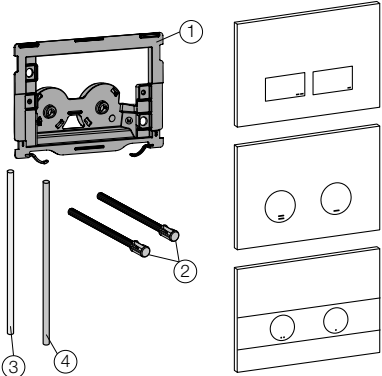
		KOD		CL	pln/szt
	①	Kompletna ramka montażowa Plate support frame complete Kit conteplaque	VS0871550	1	SP02 149,74
	②	Dystanse do montażu ramki przycisku Spacer for attaching plate Entretoises de fixation plaque	VS0864166	1	SP02 18,42
	③	Wężyk PVC biały Ø 6x4 - 360 mm White PVC pipe Ø 6x4 - 360 mm Tube PVC blanc Ø 6x4 - 360 mm	VS0804697	1	SP02 9,46
	④	Wężyk PVC niebieski Ø 6x4 - 360 mm Blue PVC pipe Ø 6x4 - 360 mm Tube PVC bleu Ø 6x4 - 360 mm	VS0804698	1	SP02 9,46

VS08717XX

TROPEA3 - CUBIK - EVOLUT PNEU

KOD



CL

pln/szt

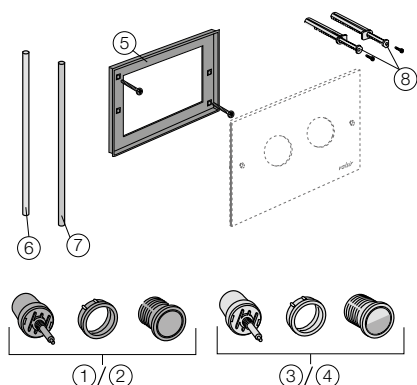

①	Zestaw popychacza dla całości splukiwania - chrom połysk Full flush button kit polished chrome Kit poussoir de commande débit total - chromé brillant	VS0875313	1	SP02	192,50
②	Zestaw popychacza dla całości splukiwania - chrom matowy Full flush button kit satin chrome Kit poussoir de commande débit total - chromé mat	VS0875317	1	SP02	192,50
③	Zestaw popychacza dla 1/2 splukiwania - chrom połysk 1/2 flush button kit polished chrome Kit poussoir de commande 1/2 débit - chromé brillant	VS0875315	1	SP02	192,50
④	Zestaw popychacza dla 1/2 splukiwania - chrom matowy 1/2 flush button kit satin chrome Kit poussoir de commande 1/2 débit - chromé mat	VS0875319	1	SP02	192,50
⑤	Ramka montażowa ze śrubami Frame with screws Contre plaque avec vis	VS0868749	1	SP02	119,58
⑥	Wążek PVC biały Ø 6x4 - 360 mm White PVC pipe Ø 6x4 - 360 mm Tube PVC blanc Ø 6x4 - 360 mm	VS0804697	1	SP02	9,46
⑦	Wążek PVC niebieski Ø 6x4 - 360 mm Blue PVC pipe Ø 6x4 - 360 mm Tube PVC bleu Ø 6x4 - 360 mm	VS0804698	1	SP02	9,46
⑧	Dystanse do montażu ramki przycisku Spacer for attaching plate Entretoises de fixation plaque	VS0864166	1	SP02	18,42

VS08725XX - VS08705XX - VS08708XX

WINNER - TROPEA2 MEC

KOD



CL

pln/szt

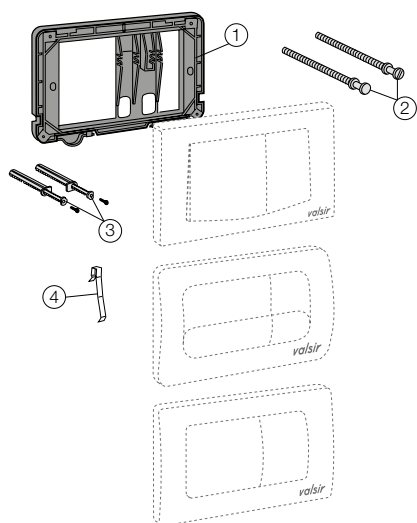

①	Ramka montażowa ze śrubami i dystansami Plate support frame complete with screws and spacers Contreplaque, vis et entretoises	VS0870848	1	SP02	92,97
②	Popychacze opróżniania całości i 1/2 nastawu Screw for push plate, total and 1/2 flush Vis de commande débit total et 1/2 débit	VS0820118	1	SP02	16,47
③	Dystanse do montażu ramki przycisku Spacer for attaching plate Entretoises de fixation plaque	VS0864166	1	SP02	18,42
④	Sprężyna Spring Ressort	VS0822127	1	SP02	9,07

VS08707XX
 WINNER - TROPEA2 PNEU

KOD  CL pln/szt

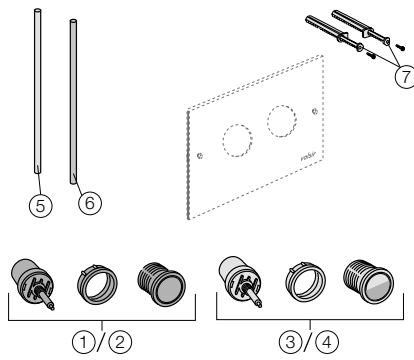
		KOD		CL	pln/szt
	① Zestaw popychacza dla całości spłukiwania - chrom połysk Full flush button kit polished chrome Kit poussoir de commande débit total - chromé brillant	VS0875313	1	SP02	192,50
	② Zestaw popychacza dla całości spłukiwania - chrom matowy Full flush button kit satin chrome Kit poussoir de commande débit total - chromé mat	VS0875317	1	SP02	192,50
	③ Zestaw popychacza dla 1/2 spłukiwania - chrom połysk 1/2 flush button kit polished chrome Kit poussoir de commande 1/2 débit - chromé brillant	VS0875315	1	SP02	192,50
	④ Zestaw popychacza dla 1/2 spłukiwania - chrom matowy 1/2 flush button kit satin chrome Kit poussoir de commande 1/2 débit - chromé mat	VS0875319	1	SP02	192,50
	⑤ Wężyk PVC biały Ø 6x4 - 360 mm White PVC pipe Ø 6x4 - 360 mm Tube PVC blanc Ø 6x4 - 360 mm	VS0804697	1	SP02	9,46
	⑥ Wężyk PVC niebieski Ø 6x4 - 360 mm Blue PVC pipe Ø 6x4 - 360 mm Tube PVC bleu Ø 6x4 - 360 mm	VS0804698	1	SP02	9,46
	⑦ Dystanse do montażu płytki przycisku Spacer for attaching plate Entretoises de fixation plaque	VS0864166	1	SP02	18,42

CRYSTAL - INOX - BLACK & WHITE

Wykończenie - Finishing

KOD



CL

pln/
szt

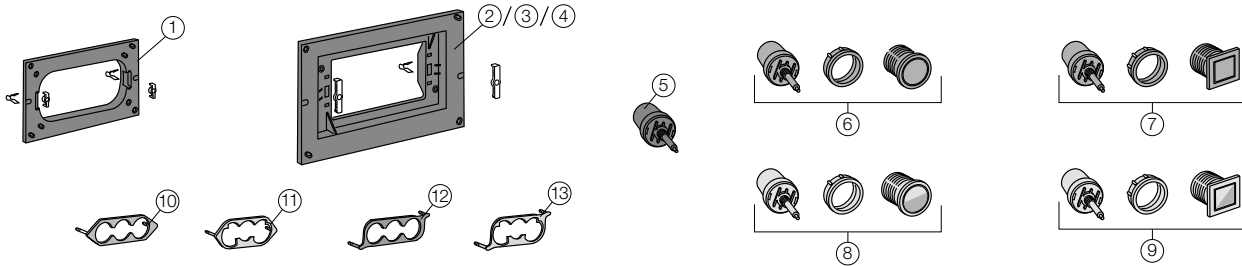

①	Ramka montażowa SMALL Plate support frame SMALL Contreplaque SMALL	połysk - polished - brillant	VS0875335	1	SP02	141,83
		matowy - satin - satin	VS0875329	1	SP02	141,83
②	Ramka montażowa MEDIUM Plate support frame MEDIUM Contreplaque MEDIUM	połysk - polished - brillant	VS0875336	1	SP02	149,38
		matowy - satin - satin	VS0875334	1	SP02	140,21
③	Ramka montażowa od 2009 do 2011 LARGE Plate support frame from 2009 to 2011 LARGE Contreplaque de 2009 à 2011 LARGE	połysk - polished - brillant	VS0875339	1	SP02	141,83
		matowy - satin - satin	VS0875333	1	SP02	141,83
④	Ramka montażowa od 2012 LARGE Plate support frame to 2012 LARGE Contreplaque de 2012 LARGE	połysk - polished - brillant	VS0875338	1	SP02	141,83
		matowy - satin - satin	VS0875332	1	SP02	141,83
⑤	Mechanizm pneumatyczny Pneumatic control mechanism Mécanisme de commande pneus		VS0875341	1	SP02	80,57
⑥	Zestaw przycisku dla całości sfluwiania - okrągły Full flush button kit - round Kit bouton d'évacuation totale - rond	połysk - polished - brillant	VS0875313	1	SP02	192,50
		matowy - satin - satin	VS0875317	1	SP02	192,50
⑦	Zestaw przycisku dla całości sfluwiania - kwadratowy Full flush button kit - square Kit bouton d'évacuation totale - carré	połysk - polished - brillant	VS0875305	1	SP02	192,50
		matowy - satin - satin	VS0875309	1	SP02	192,50
⑧	Zestaw przycisku dla 1/2 sfluwiania - okrągły 1/2 flush button kit - round Kit bouton de 1/2 évacuation - rond	połysk - polished - brillant	VS0875315	1	SP02	192,50
		matowy - satin - satin	VS0875319	1	SP02	192,50
⑨	Zestaw przycisku dla 1/2 sfluwiania - kwadratowy 1/2 flush button kit - square Kit bouton de 1/2 évacuation - carré	połysk - polished - brillant	VS0875307	1	SP02	192,50
		matowy - satin - satin	VS0875311	1	SP02	192,50
⑩	Płytki centrująca ze stali nierdzewnej - przycisk okrągły Stainless steel centre finder, round button Centreur inox, bouton rond	SMALL do - to 2009	VS0875109	1	SP02	73,11
⑪	Płytki centrująca ze stali nierdzewnej - przycisk kwadratowy Stainless steel centre finder, square button Centreur inox, bouton carré	MEDIUM/LARGE 2009-2011	VS0875110	1	SP02	73,11
⑫	Płytki centrująca ze stali nierdzewnej - przycisk okrągły Stainless steel centre finder, round button Centreur inox, bouton rond		VS0875297	1	SP02	73,11
⑬	Płytki centrująca ze stali nierdzewnej - przycisk kwadratowy Stainless steel centre finder, square button Centreur inox, bouton carré	MEDIUM/LARGE do - to 2012	VS0875298	1	SP02	73,11

WOOD - STONE - FANTASY

Wykończenie - Finishing

KOD



CL

pln/
szt

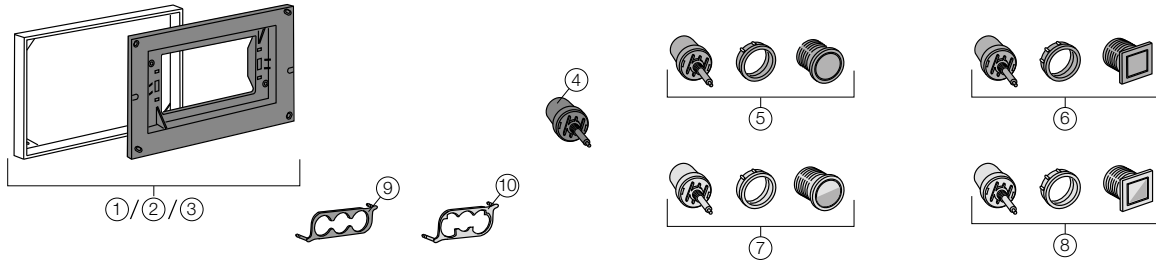

①	Zestaw płytki montażowej MEDIUM Kit plate support frame MEDIUM Kit contreplaque et cadre MEDIUM	połysk - polished - brillant	VS0875325	1	SP02	464,23
		matowy - satin - satin	VS0875321	1	SP02	418,27
②	Zestaw płytki montażowej od 2009 do 2011 LARGE Kit plate support frame from 2009 to 2011 LARGE Kit contreplaque et cadre de 2009 à 2011 LARGE	połysk - polished - brillant	VS0875327	1	SP02	464,23
		matowy - satin - satin	VS0875323	1	SP02	418,27
③	Zestaw płytki montażowej do 2012 LARGE Kit plate support frame to 2012 LARGE Kit contreplaque et cadre de 2012 LARGE	połysk - polished - brillant	VS0875328	1	SP02	464,23
		matowy - satin - satin	VS0875324	1	SP02	418,27
④	Mechanizm pneumatyczny Pneumatic control mechanism Mécanisme de commande pneus		VS0875341	1	SP02	80,57
⑤	Zestaw przycisku dla całości spłukiwania - okrągły Full flush button kit - round Kit bouton d'évacuation totale - rond	połysk - polished - brillant	VS0875313	1	SP02	192,50
		matowy - satin - satin	VS0875317	1	SP02	192,50
⑥	Zestaw przycisku dla całości spłukiwania - kwadratowy Full flush button kit - square Kit bouton d'évacuation totale - carré	połysk - polished - brillant	VS0875305	1	SP02	192,50
		matowy - satin - satin	VS0875309	1	SP02	192,50
⑦	Zestaw przycisku dla 1/2 spłukiwania - okrągły 1/2 flush button kit - round Kit bouton de 1/2 évacuation - rond	połysk - polished - brillant	VS0875315	1	SP02	192,50
		matowy - satin - satin	VS0875319	1	SP02	192,50
⑧	Zestaw przycisku dla 1/2 spłukiwania - kwadratowy 1/2 flush button kit - square Kit bouton de 1/2 évacuation - carré	połysk - polished - brillant	VS0875307	1	SP02	192,50
		matowy - satin - satin	VS0875311	1	SP02	192,50
⑨	Płytki centrująca ze stali nierdzewnej - przycisk okrągły Stainless steel centre finder, round button Centreur inox, bouton rond	SMALL do - to 2009	VS0875109	1	SP02	73,11
⑩	Płytki centrująca ze stali nierdzewnej - przycisk kwadratowy Stainless steel centre finder, square button Centreur inox, bouton carré	MEDIUM/LARGE 2009-2011	VS0875110	1	SP02	73,11
⑪	Płytki centrująca ze stali nierdzewnej - przycisk okrągły Stainless steel centre finder, round button Centreur inox, bouton rond		VS0875297	1	SP02	73,11
⑫	Płytki centrująca ze stali nierdzewnej - przycisk kwadratowy Stainless steel centre finder, square button Centreur inox, bouton carré	MEDIUM/LARGE do - to 2012	VS0875298	1	SP02	73,11

CZĘŚCI ZAMIENNE DO PRZYCISKÓW PNEUMATYCZNYCH

PNEUMATIC ACTUATORS SPARE PARTS

PIÈCES DE RECHANGE COMMANDES PNEUMATIQUE

VS08722XX

KOD



CL

pln/szt

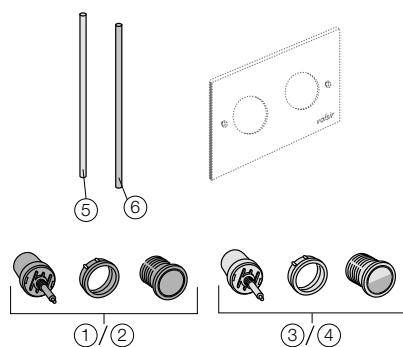

①	Zestaw popychacza dla całości splukiwania - chrom połysk Full flush button kit polished chrome Kit poussoir de commande débit total - chromé brillant	VS0875313	1	SP02	192,50
②	Zestaw popychacza dla całości splukiwania - chrom matowy Full flush button kit satin chrome Kit poussoir de commande débit total - chromé mat	VS0875317	1	SP02	192,50
③	Zestaw popychacza dla 1/2 splukiwania - chrom połysk 1/2 flush button kit polished chrome Kit poussoir de commande 1/2 débit - chromé brillant	VS0875315	1	SP02	192,50
④	Zestaw popychacza dla 1/2 splukiwania - chrom matowy 1/2 flush button kit satin chrome Kit poussoir de commande 1/2 débit - chromé mat	VS0875319	1	SP02	192,50
⑤	Wąż PVC biały Ø 6x4 - 360 mm White PVC pipe Ø 6x4 - 360 mm Tube PVC blanc Ø 6x4 - 360 mm	VS0804697	1	SP02	9,46
⑥	Wąż PVC niebieski Ø 6x4 - 360 mm Blue PVC pipe Ø 6x4 - 360 mm Tube PVC bleu Ø 6x4 - 360 mm	VS0804698	1	SP02	9,46

VS0804801

KOD



CL

pln/szt

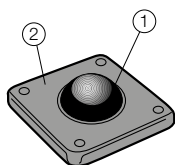

①	Gumowa osłona przycisku Rubber covering for button Cape de fermeture de poussoir	VS0804824	1	SP02	20,51
②	Płytkę zewnętrzną ze stali nierdzewnej Stainless steel flanged cover plate Bride de couverture inox	VS0804811	1	SP02	154,98

VS0804901

KOD



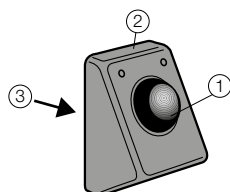

CL

pln/szt

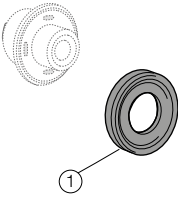

①	Gumowa osłona przycisku Rubber covering for button Cape de fermeture de poussoir	VS0804824	1	SP02	20,51
②	Płytkę zewnętrzną ze stali nierdzewnej Stainless steel flanged cover plate Bride de couverture inox	VS0804911	1	SP02	308,59
③	Zestaw pneumatycznego przycisku Pneumatic push button kit Kit bouton pneumatique	VS0804902	1	SP02	198,28

VS08023XX		Kolor Colour - Couleur	KOD		CL	pln/szt
	① Zewnętrzna oprawka External nut Cache externe	biały white blanc	VS0804625	1	SP02	27,52
		chrom połysk polished chrome chromé brillant	VS0804628	1	SP02	41,75
		chrom matowy satin chrome chromé mat	VS0804635	1	SP02	41,93

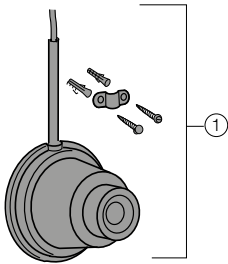
VS08024XX		Kolor Colour - Couleur	KOD		CL	pln/szt
	① Kompletny zestaw części zamiennych Complet spare part kit Kit changement complet	biały white blanc	VS0804621	1	SP02	98,49
		chrom połysk polished chrome chromé brillant	VS0804622	1	SP02	187,16
		chrom matowy satin chrome chromé mat	VS0804623	1	SP02	249,21

CZĘŚCI ZAMIENNE DO STELAŻY

MOUNTING FRAMES SPARE PARTS

PIÈCES DE RECHANGE STRUCTURES

Kolano odpływowe z uszczelką antywibracyjną Ø 50

Outlet bend with anti-vibration seal, Ø 50

Coude technique bidet avec joint isolant Ø 50

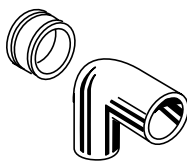

KOD		CL	pln/szt
VS0825031	1	SP02	76,64

Manszet gumowy do kolana odpływowego

Ø 50x1"1/4 - 1"1/2

Ring seal for connection bend Ø 50x1"1/4 - 1"1/2

Joint pour coude technique Ø 50x1"1/4 - 1"1/2

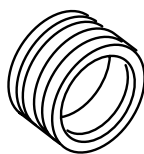

KOD		CL	pln/szt
VS0825021	1	SP02	20,87

Korek ochronny Ø 40

Protective plug Ø 40

Bouchon de protection Ø 40

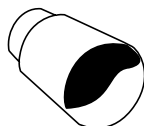



KOD		CL	pln/szt
VS0802009	1	SP02	13,47

Płytki ze śrubami do połączenia osprzętu do bidetów Fixsystem

Plate with screws for connection of fittings for Fixsystem bidet

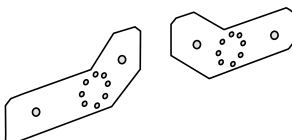
Kit platine porte raccord avec vis pour bidet Fixsystem



KOD		CL	pln/szt
VS0825030	1	SP02	51,54

Kolano mosiężne z uszczelką i śrubami

Brass fitting with seal and screws
Raccord laiton avec joint et vis

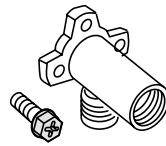

KOD			CL	pln/szt
VS0825028	3/8" Fx3/8" M	10	VA02	61,23
VS0825023	1/2" Fx1/2" M	10	VA02	63,29

Zestaw wkrętów z kołkami rozporowymi do montażu stelaża (4 szt) Ø 10

Screws and anchors for attaching frame (4 pcs) Ø 10
Kit vis, chevilles de fixation de structure (4 pz) Ø 10

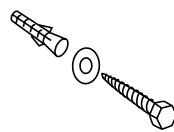

KOD			CL	pln/szt
VS0805128		1	SP02	31,68

Wspornik montażowy stelaża ze śrubą i podkładką (1 szt)

Side bracket for attaching frame with screw and washer (1 pc)
Élément latéral de fixation de la structure avec vis et rondelle (1 pièce)

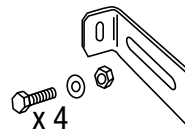

KOD	Mod.		CL	pln/szt
VS0824135	Tropea3 S90	1	SP02	27,16
VS0868613	Winner, Cubik, Evolut Angel, Tropea3 S160	1	SP02	42,40

Zestaw gwintowanych śrub, rurki PVC, nakrętki i podkładki, do montażu podwieszanej miski WC z ochronnymi zaślepkami

Threaded rods, PVC pipe, nuts and washers, for wall-hung pan attachment with protective caps
Kit tiges filetées, tube PVC, écrous, rondelles pour fixations bidet suspendu

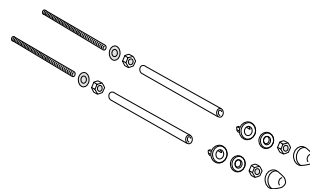



KOD		CL	pln/szt
VS0820224	1	SP02	99,72

Uchwyt kolana odpływowego - model Fixsystem

Bend support for Fixsystem
 mounting frame

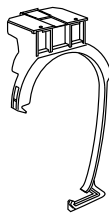
Support de coude -
 modèle Fixsystem





KOD	Mod.		CL	pln/szt
VS0826072	od - from - depuis 2009	1	SP02	28,85
VS0826066	2004 - 2008	1	SP02	33,99

Uchwyt kolana odpływowego - model Block

Bend support for Block
 mounting frame

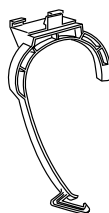
Support de coude - modèle Block



KOD	Mod.		CL	pln/szt
VS0826065	Winner, Evolut, Cubik, Space, Angel, Tropea2, Tropea3 S160	1	SP02	28,85
VS0826068	Tropea3 S90	1	SP02	54,50

Uchwyt kolana odpływowego WC, 3-pozycje ustawienia z prowadnicą

Support for wc bend 3
 positions with guide

porte coude WC 3
 positions avec guide





KOD	Mod.		CL	pln/szt
VS0868278	Tropea S, Winner S, Cubik S	1	SP02	31,42

Rura połączeniowa z PP do WC D 45 L 195 z manszetem Ø 44

PP connection pipe for WC
 D 45 L 195 with Ø 44 grommet

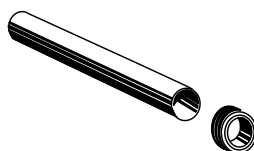
Tube PP alimentation WC
 D 45 L 195 avec joint Ø 44



KOD		CL	pln/szt
VS0803202	1	SP02	32,97

Manszet do pisuaru Ø 60x50

Seal for urinal Ø 60x50

Joint pour urinoir Ø 60x50



KOD		CL	pln/szt
VS0867655	1	SP02	28,79

Płytki zasilacza do pisuaru Blick

Power supply circuit board for Blick urinal

Carte alimentateur pour urinoir Blick

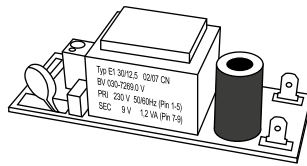



KOD		CL	pln/szt
VS0868830	1	SP02	263,55

Obudowa akumulatora do pisuaru Blick

Batteries casing for Blick urinal

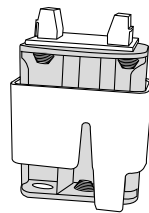
Carte porte-batterie pour urinoir Blick



KOD		CL	pln/szt
VS0868832	1	SP02	178,90

Zawór bistabilny do pisuaru Blick

Bistable valve for Blick urinal

Vanne bistable pour urinoir Blick

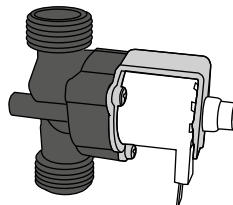

KOD		CL	pln/szt
VS0868834	1	SP02	399,53

Zawór bistabilny do pisuaru do 2013





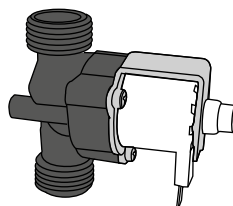

Bistable valve for urinal up 2013

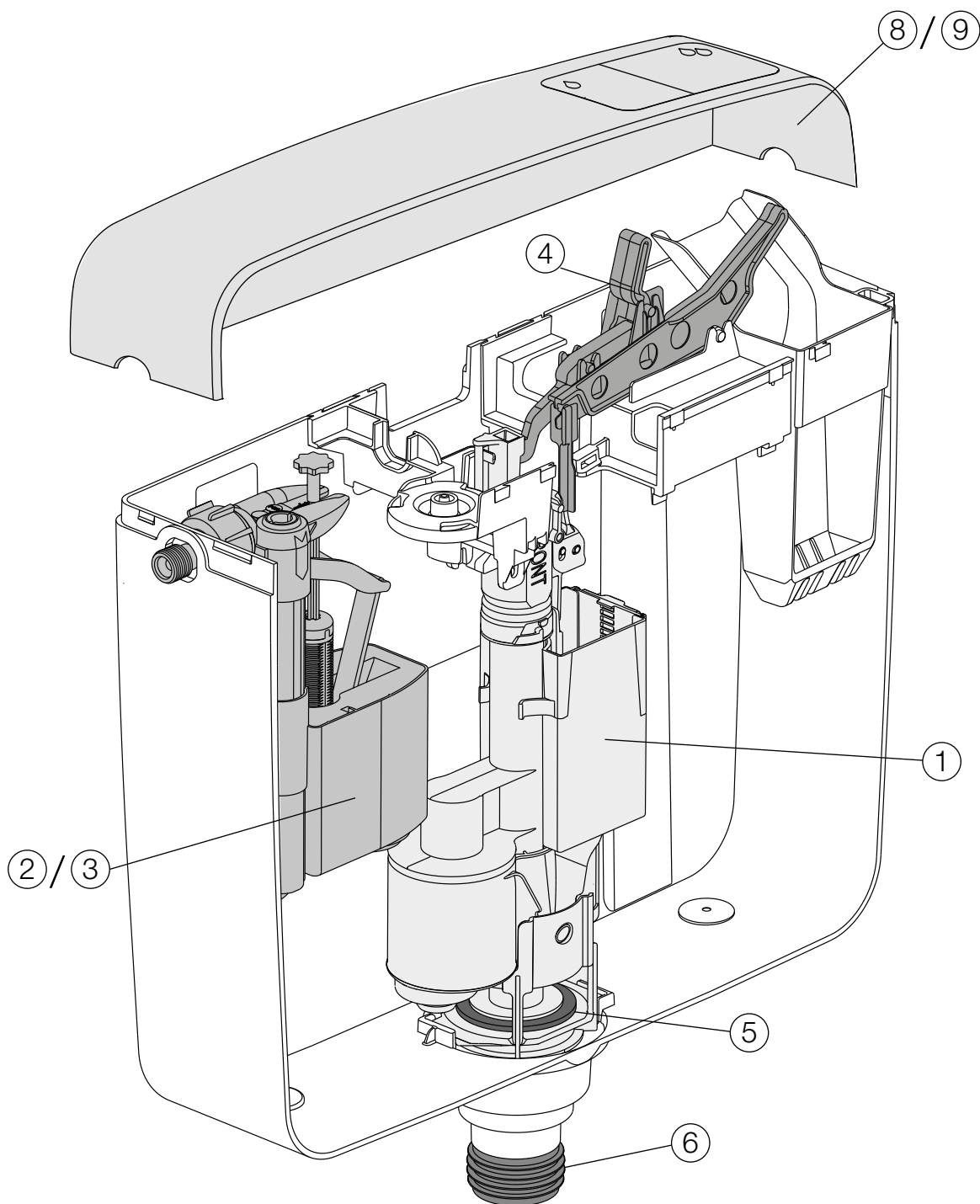
Vanne bistable pour urinoir finish en 2013



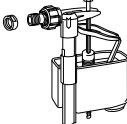
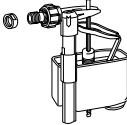
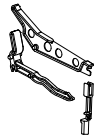
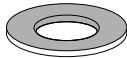

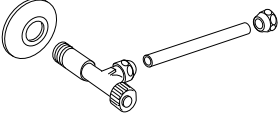
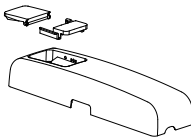
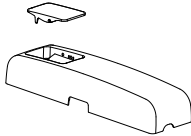
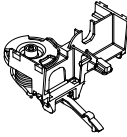
KOD		CL	pln/szt
VS0868850	1	SP02	904,59



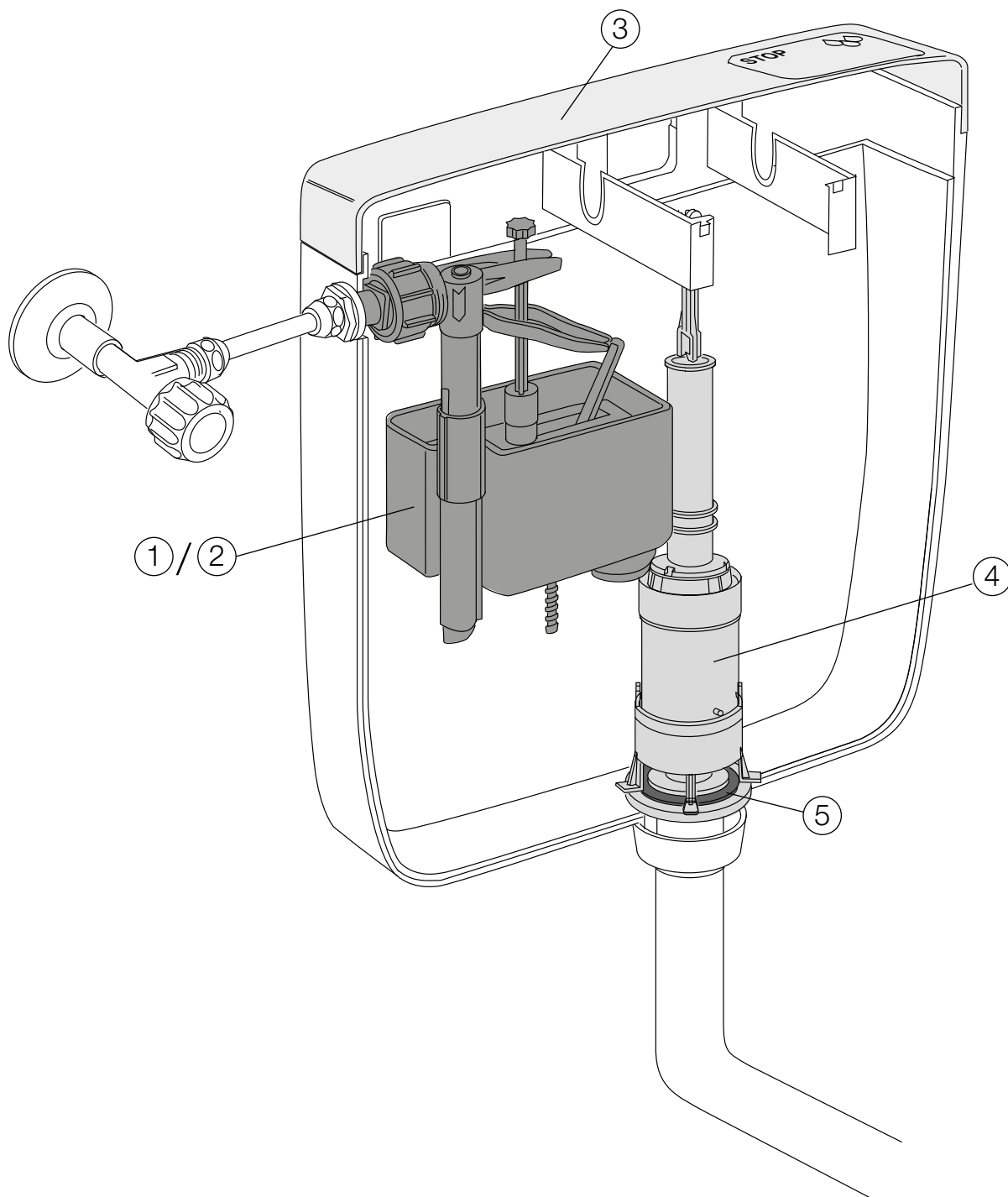

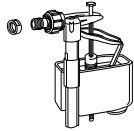
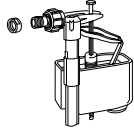
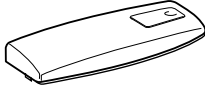



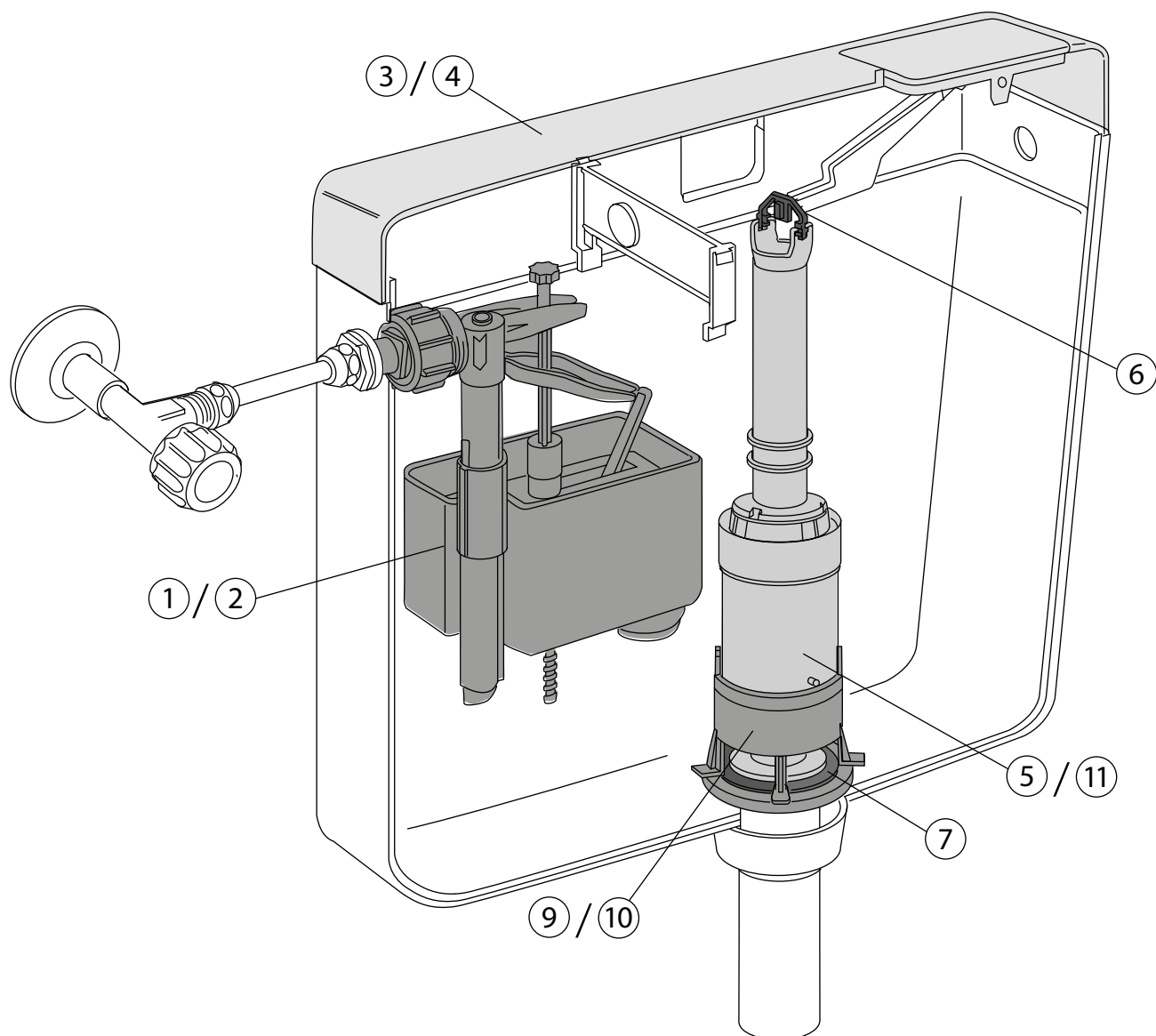

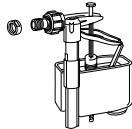
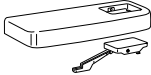

Części zamienne - Spare parts - Pièces de rechange			KOD		CL	pln/szt
①		Zawór opróżniający Outlet valve with guide Vanne avec regard	VS0817401	1	SP02	147,03
②		Zawór napełniający 3/8" Float valve 3/8" Robinet flotteur 3/8"	VS0800218	1	SP02	105,75
③		Zawór napełniający 1/2" Float valve 1/2" Robinet flotteur 1/2"	VS0800219	1	SP02	105,75
④		Zestaw mechanicznych dźwigni opróżniających Mechanical flush levers Kit leviers actionnement mécanique	VS0817403	1	SP02	45,47
⑤		Uszczelka do zaworu opróżniającego Seal for outlet valve Joint de mécanisme	VS0866603	10	SP02	10,24
⑥		Manszet gumowy Connection seal Joint de cuvette	VS0810521	10	SP02	14,33
⑦		Zestaw z zaworem odcinającym Kit stop valve Kit robinet d'arrêt	VS0810522	1	SP02	84,63
⑧		Pokrywa dla wersji mechanicznej Lid for mechinc version Couvercle pour version mécanique	VS0817404	1	SP02	80,43
⑨		Pokrywa dla wersji pneumatycznej Lid for pneumatic version Couvercle pour version pneumatique	VS0817405	1	SP02	80,43
⑩		Zestaw pneumatyczny Pneumatic kit Kit pneumatique	VS0817410	1	SP02	112,83
⑪		Wężyk w oplocie ze stali do dolnego podłączenia wody 3/8" Stainless steel hose for bottom water connection 3/8" Tuyau flexible inox avec raccord pour alimentation d'en bas 3/8"	VS0810078	1	SP02	129,98



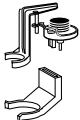





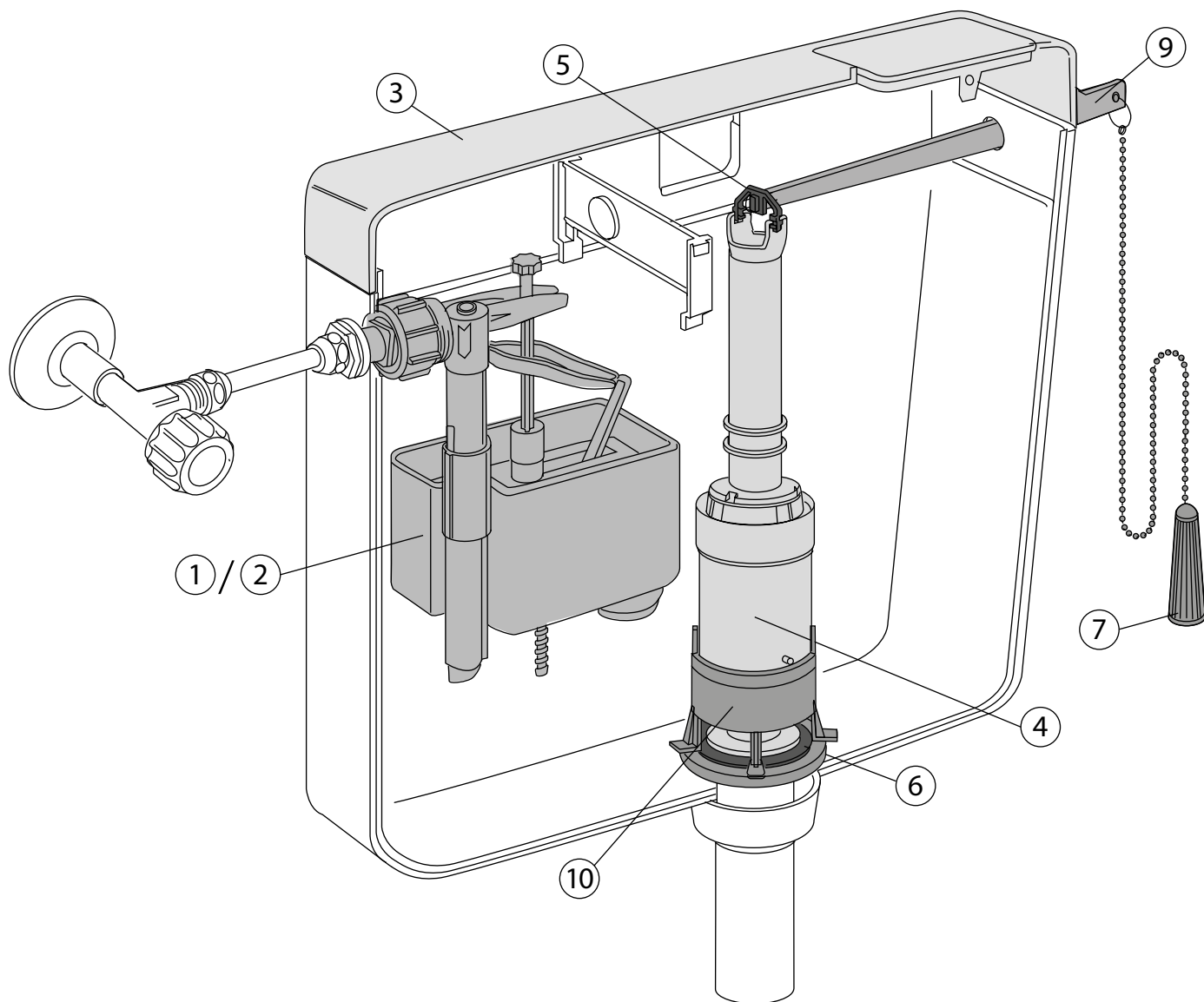

Części zamienne - Spare parts - Pièces de rechange			KOD		CL	pln/szt
①		Zawór napełniający 3/8" Mono 3/8" Mono float valve Robinet flotteur 3/8" Mono	VS0800218	1	SP02	105,75
②		Zawór napełniający 1/2" Mono 1/2" Mono float valve Robinet flotteur 1/2" Mono	VS0800219	1	SP02	105,75
③		Pokrywa z przyciskiem Lid with push button Couvercle avec poussoir	VS0846100	1	SP02	84,22
④		Zawór opróżniający z cięgiem Outlet valve with anchor Mécanisme avec accroche	VS0810293	1	SP02	85,21
⑤		Uszczelka do zaworu opróżniającego Washer for flush valve Joint de mécanisme	VS0801017	10	SP02	10,24

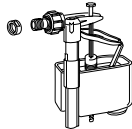
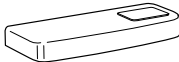

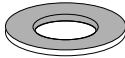

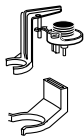

Części zamienne - Spare parts - Pièces de rechange			KOD		CL	pln/szt
①		Zawór napełniający 3/8" Mono 3/8" Mono float valve Robinet flotteur 3/8" Mono	VS0800218	1	SP02	105,75
②		Zawór napełniający 1/2" Mono 1/2" Mono float valve Robinet flotteur 1/2" Mono	VS0800219	1	SP02	105,75
③		Pokrywa z przyciskiem spłuczki Mida Lid with push button for Mida cistern Couvercle avec poussoir pour réservoir Mida	VS0850100	1	SP02	84,22
④		Pokrywa z zaślepką dla wersji pneumatycznej Lid with fixed cap pneu Couvercle fixe pour mécanisme	VS0860050	1	SP02	84,22
⑤		Zawór opróżniający z cięgiem Flush valve with anchor Mécanisme avec accroche	VS0810291	1	SP02	85,21
⑥		Cięgło Anchor Accroche	VS0850004	1	SP02	25,85
⑦		Uszczelka do zaworu opróżniającego Washer for flush valve Joint de mécanisme	VS0801017	10	SP02	10,24
⑧		Mechanizm pneumatyczny do zaworu opróżniającego Pneumatic mechanism for flush valve Mécanisme pneumatique à monter sur mécanisme	VS0804505	1	SP02	159,57
⑨		Gniazdo zaworu opróżniającego Click-in baskets Siège	VS0810159	1	SP02	28,85
⑩		Gniazdo zaworu opróżniającego z nakrętką i uszczelką dla spłuczek kompaktowych Basket with nut and seal for close-coupled cistern Siège avec écrou et joint pour réservoir monobloc	VS0810258	1	SP02	33,19
⑪		Zawór opróżniający pneumatyczny od 1996 do 2000 Pneumatic flush valve from 1996 to 2000 Mécanisme pneumatique 1996-2000	VS0804660	1	SP02	210,57

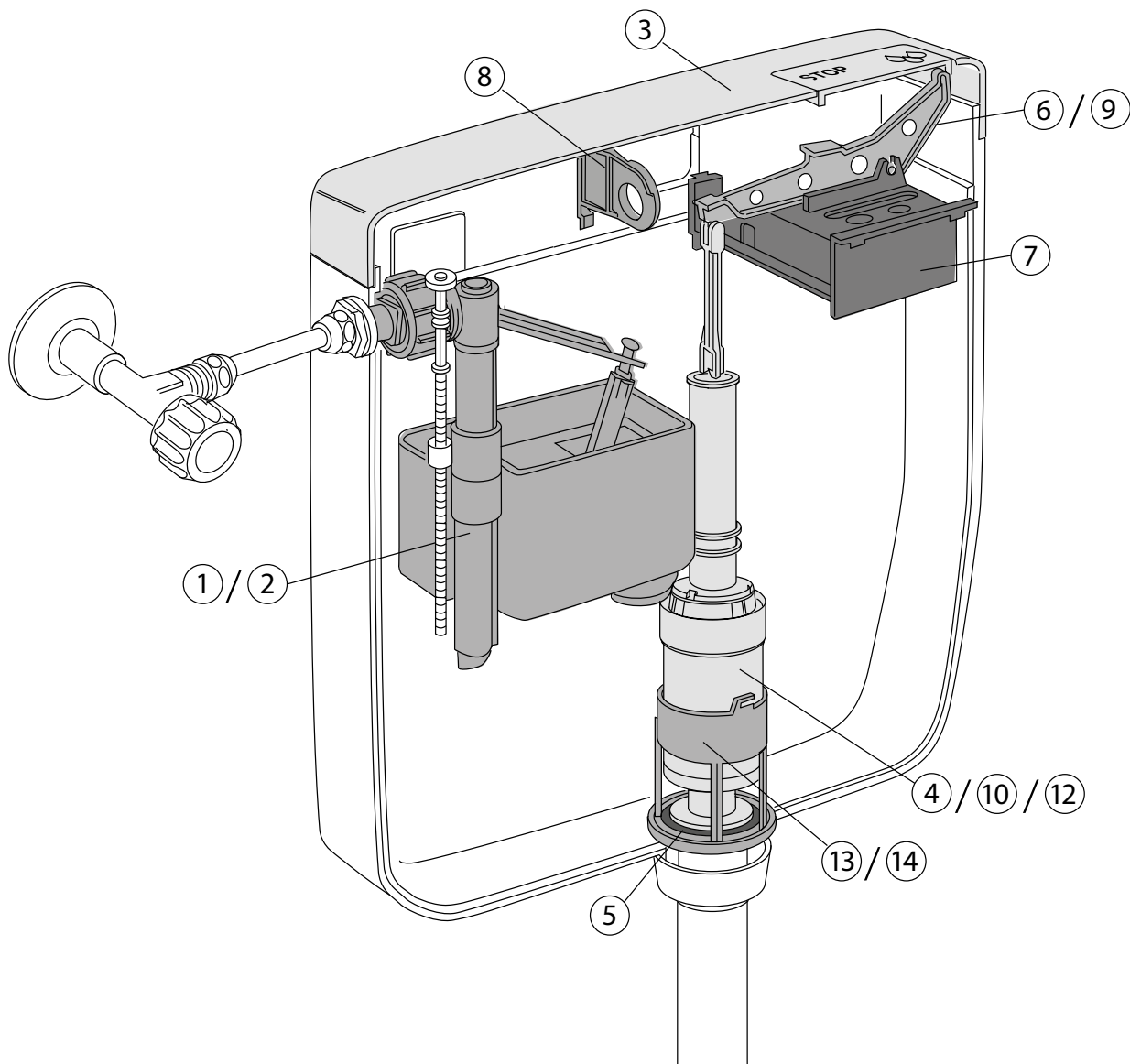









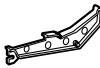
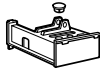

Części zamienne - Spare parts - Pièces de rechange			KOD		CL	pln/szt
①		Zawór napełniający 3/8" Mono 3/8" Mono float valve Robinet flotteur 3/8" Mono	VS0800218	1	SP02	105,75
②		Zawór napełniający 1/2" Mono 1/2" Mono float valve Robinet flotteur 1/2" Mono	VS0800219	1	SP02	105,75
③		Pokrywa z zaślepką Lid with fixed cap Couvercle fixe pour mécanisme	VS0860050	1	SP02	84,22
④		Zawór opróżniający z cięgiem od 2001 do 2015 Flush valve with anchor from 2001 to 2015 Mécanisme avec accroche 2001-2015	VS0810291	1	SP02	85,21
⑤		Cięgło Anchor Accroche	VS0850004	1	SP02	25,85
⑥		Uszczelka do zaworu opróżniającego Seal for flush valve Joint de mécanisme	VS0801017	10	SP02	10,24
⑦		Łańcuszek z białym uchwytem Chain with white handle Chainette avec poignée blanche	VS0850050	1	SP02	22,54
⑧		Mechanizm pneumatyczny do zaworu opróżniającego od 2000 do 2015 Pneumatic mechanism for flush valve from 2000 to 2015 Mécanisme pneumatique à monter sur mécanisme 2000-2015	VS0804505	1	SP02	159,57
⑨		Dźwignia opróżniania Control lever Lever de commande	VS0850022	1	SP02	19,86
⑩		Gniazdo zaworu opróżniającego z nakrętką i uszczelką dla spłuczek kompaktowych Basket with nut and seal for close-coupled cistern Siège avec écrou et joint pour réservoir monobloc	VS0810258	1	SP02	33,19

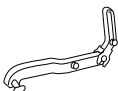



Części zamienne - Spare parts - Pièces de rechange



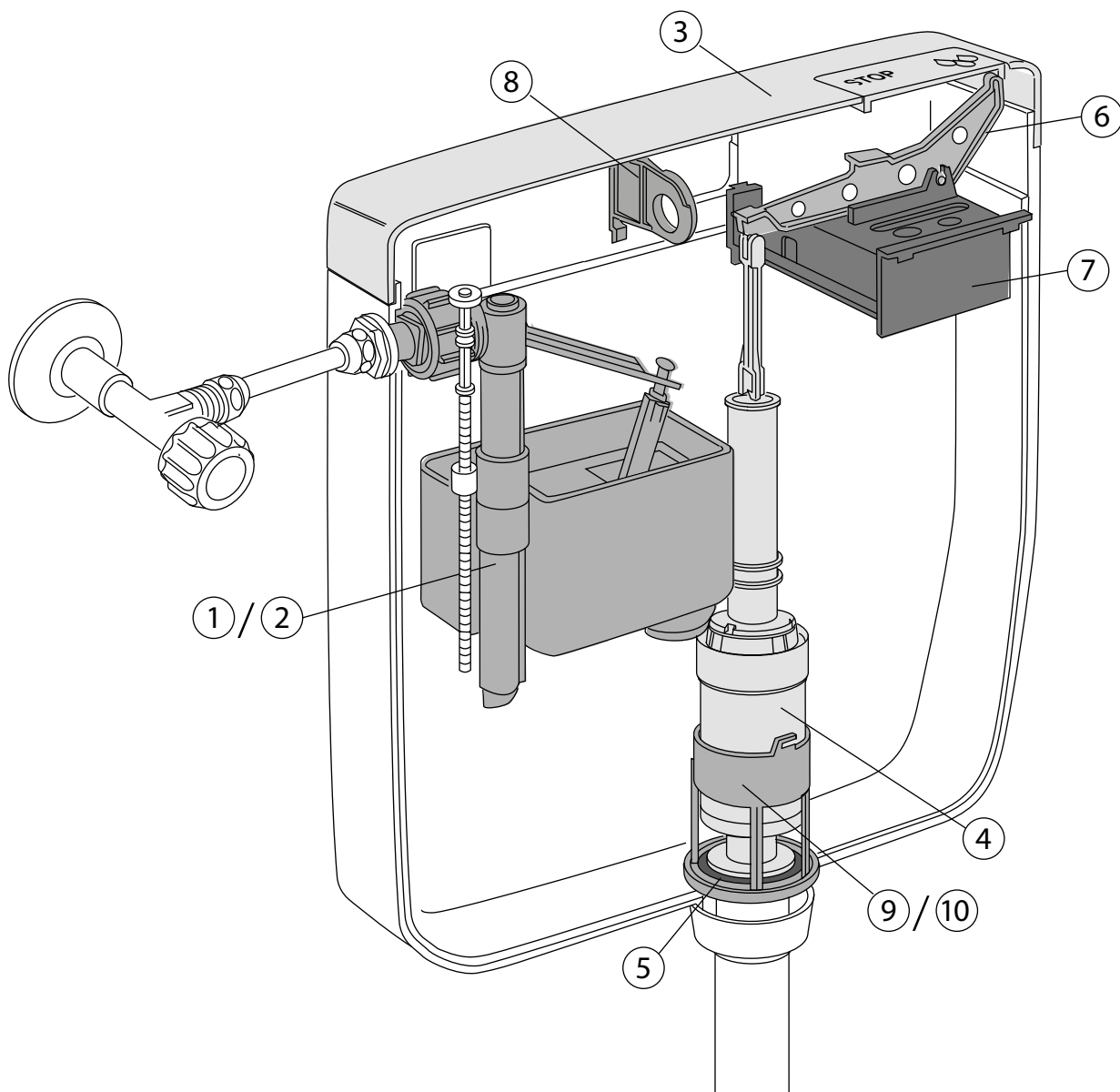

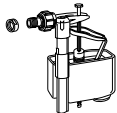

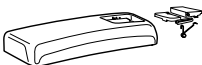

			KOD		CL	pln/szt
①		Zawór napełniający 3/8" Mono 3/8" Mono float valve Robinet flotteur 3/8" Mono	VS0800218	1	SP02	105,75
②		Zawór napełniający 1/2" Mono 1/2" Mono float valve Robinet flotteur 1/2" Mono	VS0800219	1	SP02	105,75
③		Pokrywa z przyciskiem spłuczki Atlanta Lid for Atlanta cistern with push button Couvercle avec poussoir pour réservoir Atlanta	VS0838001	1	SP02	102,29

Części zamienne - Spare parts - Pièces de rechange

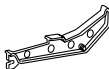
			KOD		CL	pln/szt
④		Zawór opróżniający od 2001 do 2016 Flush valve from 2001 to 2016 Mécanisme 2001-2016	VS0810251	1	SP02	79,89
⑤		Uszczelka do zaworu opróżniającego Washer for flush valve Joint de mécanisme	VS0801017	10	SP02	10,24
⑥		Dźwignia pełnego opróżnienia Full flush lever Lever de commande débit total	VS0810157	1	SP02	22,86
⑦		Blokada centralna dla dźwigni opróżniania Central block for lever Bloc central porte levier	VS0838591	1	SP02	30,02
⑧		Uchwyt mocowania zaworu napieniającego Element for holding float valve Support robinet flotteur	VS0838501	1	SP02	21,17
⑨		Dźwignia częściowego opróżnienia Half flush lever Lever de commande débit partiel	VS0810166	1	SP02	22,86
⑩		Zawór opróżniający z podwójną objętością spłukiwania, z cięgiem i dźwignią opróżniania od 2001 do 2016 Dual flush valve with anchor and kit with lever from 2001 to 2016 Vanne d'évacuation 2 quantité avec ancre et kit leviers mouvement de 2001 à 2016	VS0810148	1	SP02	124,39
⑪		Mechanizm pneumatyczny do spłuczki Atlanta od 2001 do 2016 Pneumatic mechanism for Atlanta from 2001 to 2016 Mécanisme pneumatique Atlanta 2001-2016	VS0804505	1	SP02	159,57
⑫		Zawór opróżniający pneumatyczny od 1994 do 2000 Pneumatic flush valve from 1994 to 2000 Mécanisme pneumatique Atlanta 1994-2000	VS0804660	1	SP02	210,57
⑬		Gniazdo zaworu opróżniającego z nakrętką i uszczelką dla spłuczek kompaktowych Basket with nut and seal for close-coupled cistern Siège avec écrou et joint pour réservoir monobloc	VS0810258	1	SP02	33,19
⑭		Gniazdo zaworu opróżniającego z nakrętką i uszczelką dla spłuczek montowanych w niskim i pośrednim położeniu Basket with nut and seal for low-and medium level cistern Siège avec écrou et joint pour réservoir bas mi haut	VS0810261	1	SP02	33,19

Części zamienne - Spare parts - Pièces de rechange

			KOD		CL	pln/szt
①		Zawór napełniający 3/8" Mono 3/8" Mono float valve Robinet flotteur 3/8" Mono	VS0800218	1	SP02	105,75
②		Zawór napełniający 1/2" Mono 1/2" Mono float valve Robinet flotteur 1/2" Mono	VS0800219	1	SP02	105,75
③		Pokrywa z przyciskiem spłuczki Solea Lid for Solea cistern with push button Couvercle avec poussoir pour réservoir Solea	VS0838801	1	SP02	102,29

Części zamienne - Spare parts - Pièces de rechange			KOD		CL	pln/szt
④		Zawór opróżniający od 2001 do 2016 Flush valve from 2001 to 2016 Mécanisme 2001-2016	VS0810251	1	SP02	79,89
⑤		Uszczelka do zaworu opróżniającego Seal for flush valve Joint de mécanisme	VS0801017	10	SP02	10,24
⑥		Dźwignia opróżniania Lever Levier	VS0810106	1	SP02	22,86
⑦		Blokada centralna dla dźwigni opróżniania Central block for lever Bloc central porte levier	VS0838401	1	SP02	32,39
⑧		Uchwyt mocowania zaworu napieniającego Element for holding float valve Support robinet flotteur	VS0838501	1	SP02	21,17
⑨		Gniazdo zaworu opróżniającego z nakrętką i uszczelką dla spłuczek kompaktowych Basket with nut and seal for close-coupled cistern Siège avec écrou et joint pour réservoir monobloc	VS0810258	1	SP02	33,19
⑩		Gniazdo zaworu opróżniającego z nakrętką i uszczelką dla spłuczek montowanych w niskim i pośrednim położeniu Basket with nut and seal for low-and medium level cistern Siège avec écrou et joint pour réservoir bas mi haut	VS0810261	1	SP02	33,19
⑪		Mechanizm pneumatyczny spłuczki Solea od 2001 do 2016 Pneumatic mechanism for Solea from 2001 to 2016 Mécanisme pneumatique Solea 2001-2016	VS0804505	1	SP02	159,57

Handwriting practice lines with 12 icons on the right side: a vertical bar, a semi-circle, a flame, a teardrop, a swirl, a hook, a swastika, a U-shape, a teardrop, a spiral, a triangle, a vertical bar, and a wavy line.

AKCESORIA I CZĘŚCI ZAMIENNE DO TOWARÓW PRODUKOWANYCH DO 2015 ROKU

AKCESORIAES AND SPARE PARTS FOR PRODUCTION
UP TO 2015

ACCESSOIRES ET PIÈCES DE RECHANGE
POUR PRODUITS FINIS EN 2015

PRZYCISKI DO SPŁUCZEK WYCOFANYCH Z PRODUKCJI

PUSH PLATES OF FLUSH CISTERNS OUT OF PRODUCTION

PLAQUES DE COMMANDE RÉSERVOIRS HORS PRODUCTION

Przycisk mechaniczny z podwójną objętością spłukiwania

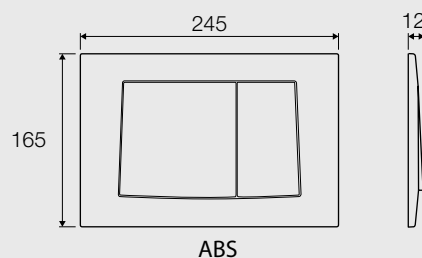

Dual flush push plate, mechanical

Plaque de commande mécanique double débit



WINNER - TROPEA2

KOD	Kolor - Colour - Couleur		CL	pln/szt
VS0872501	biały - white - blanc	5	SP01	202,36
VS0872535	chrom połysk - polished chrome - chromé brillant	5	SP01	353,74
VS0872537	chrom matowy - satin chrome - chromé mat	5	SP01	384,89

	Szt - Pcs	HxLxP	kg	m ³		Szt - Pcs	HxLxP	kg	m ³		Szt - Pcs	HxLxP	kg	m ³
	1	48x270x180	0,5	0,002		5	195x275x280	2,5	0,015		300	1130x800x1200	158	1,08

Przycisk mechaniczny z podwójną objętością spłukiwania

Dual flush push plate, mechanical

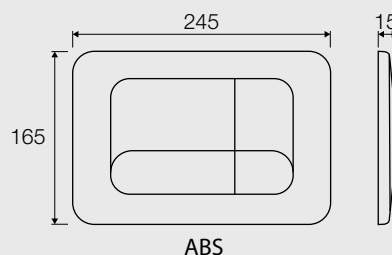
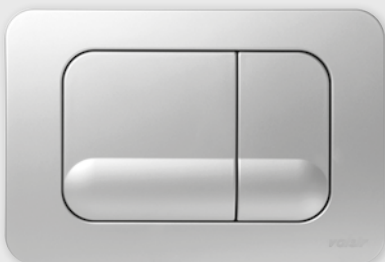

Plaque de commande mécanique double débit



WINNER - TROPEA2

KOD	Kolor - Colour - Couleur		CL	pln/szt
VS0870501	biały - white - blanc	5	SP01	202,36
VS0870503 •	szampański - champagne	5	SP01	177,76
VS0870535	chrom połysk - polished chrome - chromé brillant	5	SP01	353,74
VS0870537	chrom matowy - satin chrome - chromé mat	5	SP01	384,89

• Wyprzedaż - Sell out - Fin de stock.

	Szt - Pcs	HxLxP	kg	m ³		Szt - Pcs	HxLxP	kg	m ³		Szt - Pcs	HxLxP	kg	m ³
	1	48x270x180	0,5	0,002		5	195x275x280	2,5	0,015		300	1130x800x1200	158	1,08

Przycisk mechaniczny z podwójną objętością spłukiwania

Dual flush push plate, mechanical

Plaque de commande mécanique double débit

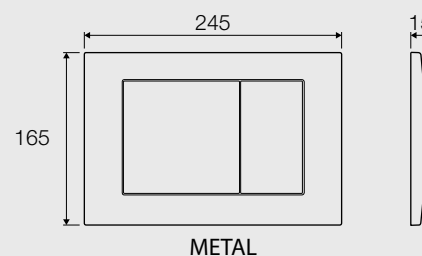

WINNER - TROPEA2

KOD	Kolor - Colour - Couleur		CL	pln/szt
VS0870835	chrom połysk - polished chrome - chromé brillant	5	SP01	911,25
VS0870837	chrom matowy - satin chrome - chromé mat	5	SP01	1 053,69

	Szt - Pcs	HxLxP	kg	m ³
	1	48x270x180	1,2	0,002

	Szt - Pcs	HxLxP	kg	m ³
	5	195x275x280	6	0,015

	Szt - Pcs	HxLxP	kg	m ³
	300	1130x800x1200	368	1,08

Akcesoria - Akcesoriaes - Accessoires

Łącznik do mechanicznych przycisków o dużych wymiarach (245x165 mm)

Adapter for large plates (245x165 mm) mechanical

Adaptateur de plaques larges (245x165 mm) mécaniques

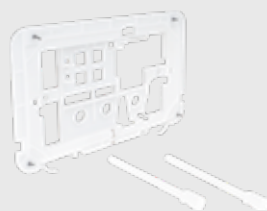

KOD		CL	pln/szt
VS0870230	1	SP01	87,39

Przycisk pneumatyczny z podwójną objętością spłukiwania

Dual flush pneumatic buttons

Plaque pneumatique double débit

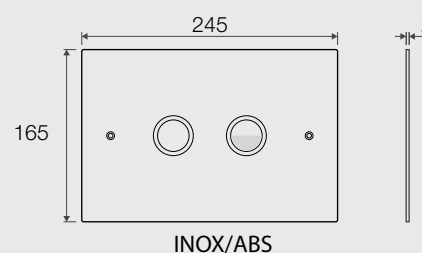

WINNER - TROPEA2

KOD	Kolor - Colour - Couleur		CL	pln/szt
VS0870735	inox połysk - polished stainless steel - inox brillant	1	SP01	955,76
VS0870737	inox matowy - satin stainless steel - inox mat	1	SP01	1 140,42

	Szt - Pcs	HxLxP	kg	m ³
	1	110x265x180	1,00	0,005

Przycisk mechaniczny z podwójną objętością spłukiwania

Dual flush push plate, mechanical

Plaque mecanique double débit

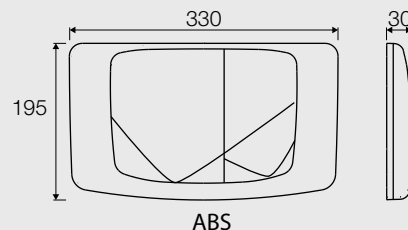

ANGEL - RIOS

KOD	Kolor - Colour - Couleur		CL	pln/szt
VS0828501	biały - white - blanc		SP01	201,75
VS0828535	chrom połysk - polished chrome - chromé brillant		SP01	378,71
VS0828537	chrom matowy - satin chrome - chromé mat		SP01	409,11
VS0828601	biały - white - blanc	wandaloodporny - tamper-proof - inviolable	SP01	255,71
VS0828635	chrom połysk - polished chrome - chromé brillant	wandaloodporny - tamper-proof - inviolable	SP01	417,38
VS0828637	chrom matowy - satin chrome - chromé mat	wandaloodporny - tamper-proof - inviolable	SP01	441,70

	Szt - Pcs	HxLxP	kg	m ³
	1	47x352x200	0,7	0,004

	Szt - Pcs	HxLxP	kg	m ³
	5	210x360x265	3,5	0,02

	Szt - Pcs	HxLxP	kg	m ³
	225	1200x800x1200	167	1,15

Akcesoria - Akcesoriaes - Accessoires

Zestaw przedłużający mocowania przycisku

Extension kit for fixing plate

Kit de rallonge fixation plaque

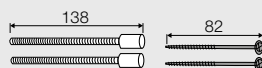

KOD		CL	pln/szt
VS0820222	1	SP02	51,72

Przycisk mechaniczny z pojedynczą objętością spłukiwania - ABS

Single flush push plate, mechanical - ABS

Plaque mecanique simple débit

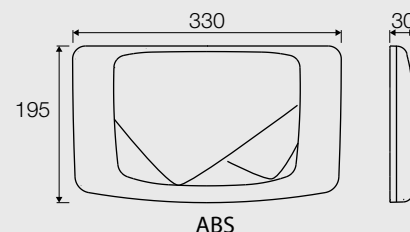



ANGEL - RIOS

KOD	Kolor - Colour - Couleur		CL	pln/szt
VS0828001	biały - white - blanc	5	SP01	183,00
VS0828003 •	szampański - champagne	5	SP01	160,14
VS0828005 •	szary manhattan - manhattan grey - gris manhattan	5	SP01	160,14

• Wypzedaż. - Sell out. - Fin de stock.

	Szt - Pcs	HxLxP	kg	m ³
	1	47x352x200	0,7	0,004

	Szt - Pcs	HxLxP	kg	m ³
	5	210x360x265	3,5	0,021

	Szt - Pcs	HxLxP	kg	m ³
	225	1200x800x1200	167	1,15

Przycisk mechaniczny z pojedynczą objętością spłukiwania

Single flush push plate, mechanical

Plaque mecanique simple débit

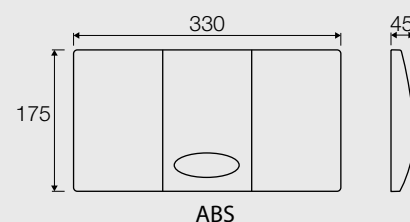



ANGEL - RIOS

KOD	Kolor - Colour - Couleur		CL	pln/szt	
VS0822001	biały - white - blanc	5	SP01	173,06	
VS0822003 •	szampański - champagne	5	SP01	160,14	
VS0822017 •	beżowy - beige - vison beige	5	SP01	160,14	
VS0822301	biały - white - blanc	wandaloodporny - tamper-proof - inviolable	5	SP01	216,51

• Wypzedaż. - Sell out. - Fin de stock.

	Szt - Pcs	HxLxP	kg	m ³
	1	47x352x200	0,7	0,004

	Szt - Pcs	HxLxP	kg	m ³
	5	210x360x265	3,5	0,02

	Szt - Pcs	HxLxP	kg	m ³
	225	1200x800x1200	167	1,15

Płytki zaślepiąco rewizyjna

Access plate
 Plaque d'inspection

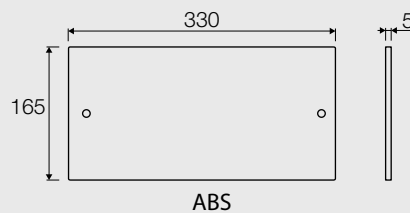

ANGEL - RIOS

KOD	Kolor - Colour - Couleur		CL	pln/szt
VS0804501	biały - white - blanc	1	SP01	135,96
VS0804535	chrom połysk - polished chrome - chromé brillant	1	SP01	214,59
VS0804537	chrom matowy - satin chrome - chromé mat	1	SP01	198,69

	Szt - Pcs	HxLxP	kg	m ³
	1	20x310x175	0,24	0,001

Przycisk mechaniczny z pojedynczą objętością spłukiwania

Single flush push plate, mechanical
 Plaque mecanique simple débit

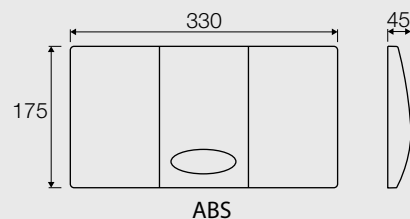

MEDUSA

KOD	Kolor - Colour - Couleur		CL	pln/szt
VS0804001	biały - white - blanc	5	SP01	171,13
VS0804035	chrom połysk - polished chrome - chromé brillant	5	SP01	331,88

	Szt - Pcs	HxLxP	kg	m ³
	1	47x352x200	0,7	0,004

	Szt - Pcs	HxLxP	kg	m ³
	5	210x360x265	3,5	0,02

	Szt - Pcs	HxLxP	kg	m ³
	225	1200x800x1200	167	1,15

Płytkę zaślepiającą rewizyjną

Access plate

Plaque d'inspection

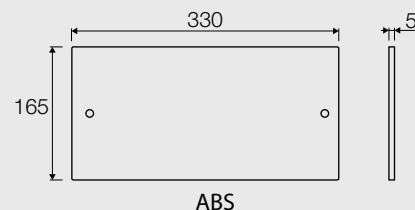

MEDUSA

KOD	Kolor - Colour - Couleur		CL	pln/szt
VS0804501	biały - white - blanc	1	SP01	135,96
VS0804535	chrom połysk - polished chrome - chromé brillant	1	SP01	214,59
VS0804537	chrom matowy - satin chrome - chromé mat	1	SP01	198,69

	Szt - Pcs	HxLxP	kg	m ³
	1	20x310x175	0,24	0,001

Przycisk mechaniczny z pojedynczą objętością spłukiwania 6/4 litrów + stop

Mechanical push plate
6/4 litres + stop

Placca di comando 6/4 litri
+ stop Mechaniczny

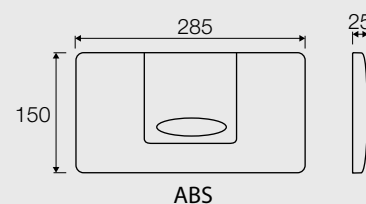



EGEA

KOD	Kolor - Colour - Couleur		CL	pln/szt	
VS0823401	biały - white - blanc	5	SP01	178,01	
VS0823435	chrom połysk - polished chrome - chromé brillant	5	SP01	332,54	
VS0823437	chrom matowy - satin chrome - chromé mat	5	SP01	360,44	
VS0823438	złoty - gold finish - doré	5	SP01	436,41	
VS0823201	biały - white - blanc	wandaloodporny - tamper-proof - inviolable	5	SP01	240,52

• Wyprzedaż - Sell out - Fin de stock.

	Szt - Pcs	HxLxP	kg	m ³
	1	47x352x200	0,54	0,004

	Szt - Pcs	HxLxP	kg	m ³
	5	210x360x265	2,7	0,02

	Szt - Pcs	HxLxP	kg	m ³
	225	1200x800x1200	130	1,15

Płytki zaślepijaco rewizyjna

Access plate

Plaque d'inspection

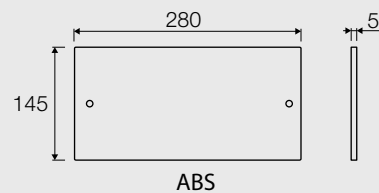

EGEA

KOD	Kolor - Colour - Couleur		CL	pln/szt
VS0823801	biały - white - blanc	1	SP01	135,43

	Szt - Pcs	HxLxP	kg	m ³
	1	20x310x175	0,2	0,001

Płytki zaślepijaco rewizyjna

Access plate

Plaque d'inspection

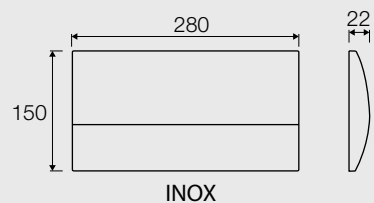

EGEA

KOD	Kolor - Colour - Couleur		CL	pln/szt
VS0823900 •	inox - stainless steel - inox	1	SP01	268,66

• Wyprzedaż. - Sell out. - Fin de stock.

	Szt - Pcs	HxLxP	kg	m ³
	1	50x295x165	0,63	0,002

Przycisk mechaniczny z pojedynczą objętością spłukiwania

Single flush push plate, mechanical
Plaque mecanique simple débit

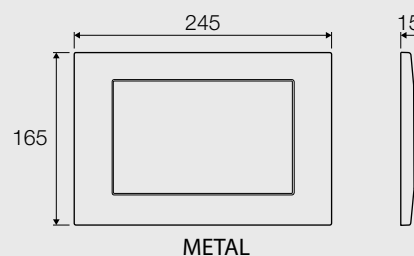

WINNER - TROPEA2

KOD	Kolor - Colour - Couleur		CL	pln/szt
VS0870337 •	chrom matowy - satin chrome - chromé mat	5	SP01	752,81

• Wyprzedaż. - Sell out. - Fin de stock.

	Szt - Pcs	HxLxP	kg	m ³
	1	48x270x180	1,1	0,002

	Szt - Pcs	HxLxP	kg	m ³
	5	195x275x280	5,5	0,015

Przycisk pneumatyczny z pojedynczą objętością spłukiwania

Single flush pneumatic buttons
Plaque pneumatique simple débit

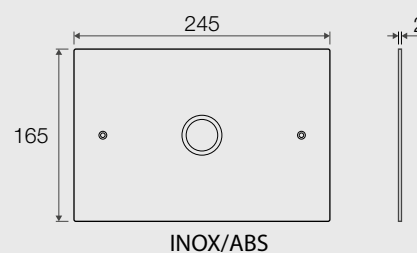

WINNER - TROPEA2

KOD	Kolor - Colour - Couleur		CL	pln/szt
VS0870637 •	inox matowy - satin stainless steel - inox mat	1	SP01	608,49

• Wyprzedaż. - Sell out. - Fin de stock.

	Szt - Pcs	HxLxP	kg	m ³
	1	110x265x180	0,9	0,005

PRZYCISKI PNEUMATYCZNE MAŁYCH WYMIARÓW

SPACE-SAVING PNEUMATIC ACTUATORS

COMMANDES PNEUMATIQUES FAIBLE ENCOMBREMENT

Przycisk małych wymiarów dla 1/2 i całkowitego spłukiwania

1/2 flush and total flush space saving buttons

Boutons poussoirs faible encombrement évacuation partielle et totale

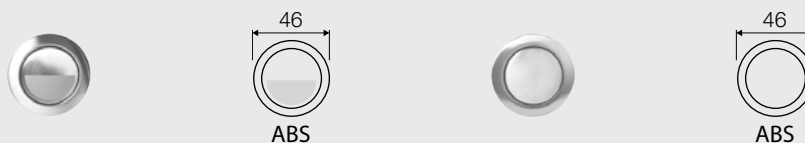

1/2 spuknięcia - 1/2 flush - 1/2 évacuation

KOD	Kolor - Colour - Couleur		CL	pln/szt
VS0802935	chrom połysk - polished chrome - chromé brillant	1	SP01	312,60
VS0802937	chrom matowy - satin chrome - chromé mat	1	SP01	395,80

Całkowite spłuknięcie - Total flush - Évacuation totale

KOD	Kolor - Colour - Couleur		CL	pln/szt
VS0802535	chrom połysk - polished chrome - chromé brillant	1	SP01	290,58
VS0802537	chrom matowy - satin chrome - chromé mat	1	SP01	370,42

Opakowanie nie zawiera zestawu z pneumatycznymi wężykami przyłączeniowymi. - The kit with pneumatic connection hoses is not included in delivery scope. - Sans le kit tuyaux de raccordement pneumatique. (VS0872204)

	Szt - Pcs	HxLxP	kg	m ³
	1	110x110x125	0,2	0,0015

Przycisk małych wymiarów z metalową płytką, z pojedynczą objętością spłukiwania

Space-saving actuators with metal plate for single volume flush

Bouton poussoir faible encombrement avec plaque métallique évacuation totale

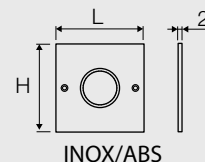

W ścianie - in-wall - A encaster

KOD	Kolor - Colour - Couleur	SxLxH		CL	pln/szt
VS0872335	chrom połysk - polished chrome - chromé brillant	2x100x100	1	SP01	450,93
VS0872337	chrom matowy - satin chrome - chromé mat	2x100x100	1	SP01	575,16

Pod karton-gips - For plasterboard - Pour plaque de plâtre

KOD	Kolor - Colour - Couleur	SxLxH		CL	pln/szt
VS0802835	chrom połysk - polished chrome - chromé brillant	2x85x85	1	SP01	371,44
VS0802837	chrom matowy - satin chrome - chromé mat	2x85x85	1	SP01	474,46

Opakowanie nie zawiera zestawu z pneumatycznymi wężykami przyłączeniowymi. - The kit with pneumatic connection hoses is not included in delivery scope. - Sans le kit tuyaux de raccordement pneumatique. (VS0872204)

	Szt - Pcs	HxLxP	kg	m ³
	1	110x110x125	0,32	0,0015

Płytki zaślepijaco rewizyjna

Access plate

Plaque d'inspection

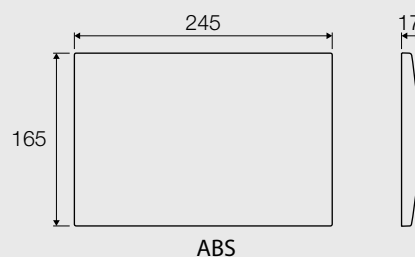
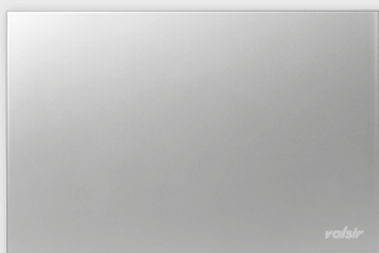

WINNER - TROPEA2

KOD	Kolor - Colour - Couleur		CL	pln/szt
VS0870401	biały - white - blanc	1	SP01	172,14
VS0870435	chrom połysk - polished chrome - chromé brillant	1	SP01	273,32
VS0870437	chrom matowy - satin chrome - chromé mat	1	SP01	303,80

	Szt - Pcs	HxLxP	kg	m ³
	1	48x270x180	0,4	0,002

Płytki zaślepijaco rewizyjna

Access plate

Plaque d'inspection

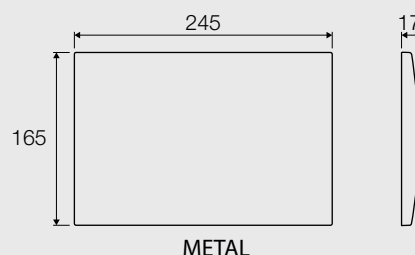
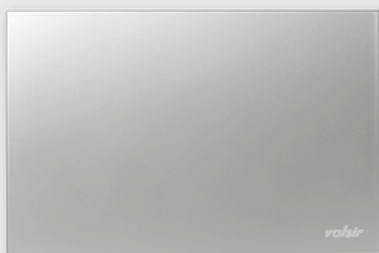

WINNER - TROPEA2

KOD	Kolor - Colour - Couleur		CL	pln/szt
VS0870901	biały - white - blanc	1	SP01	718,70
VS0870935	chrom połysk - polished chrome - chromé brillant	1	SP01	856,94
VS0870937 •	chrom matowy - satin chrome - chromé mat	1	SP01	634,58

• Wyprzedaż. - Sell out. - Fin de stock.

	Szt - Pcs	HxLxP	kg	m ³
	1	48x270x180	0,9	0,002

AKCESORIA DO TROPEA2, WINNER, CUBIK, EVOLUT

ACCESSORIES FOR TROPEA2, WINNER, CUBIK, EVOLUT

ACCESSOIRES POUR TROPEA2, WINNER, CUBIK, EVOLUT

Kolano z kwadratowym kołnierzem

Square flanged elbow



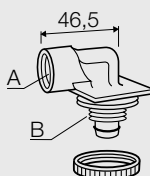



Raccord coudé à bride

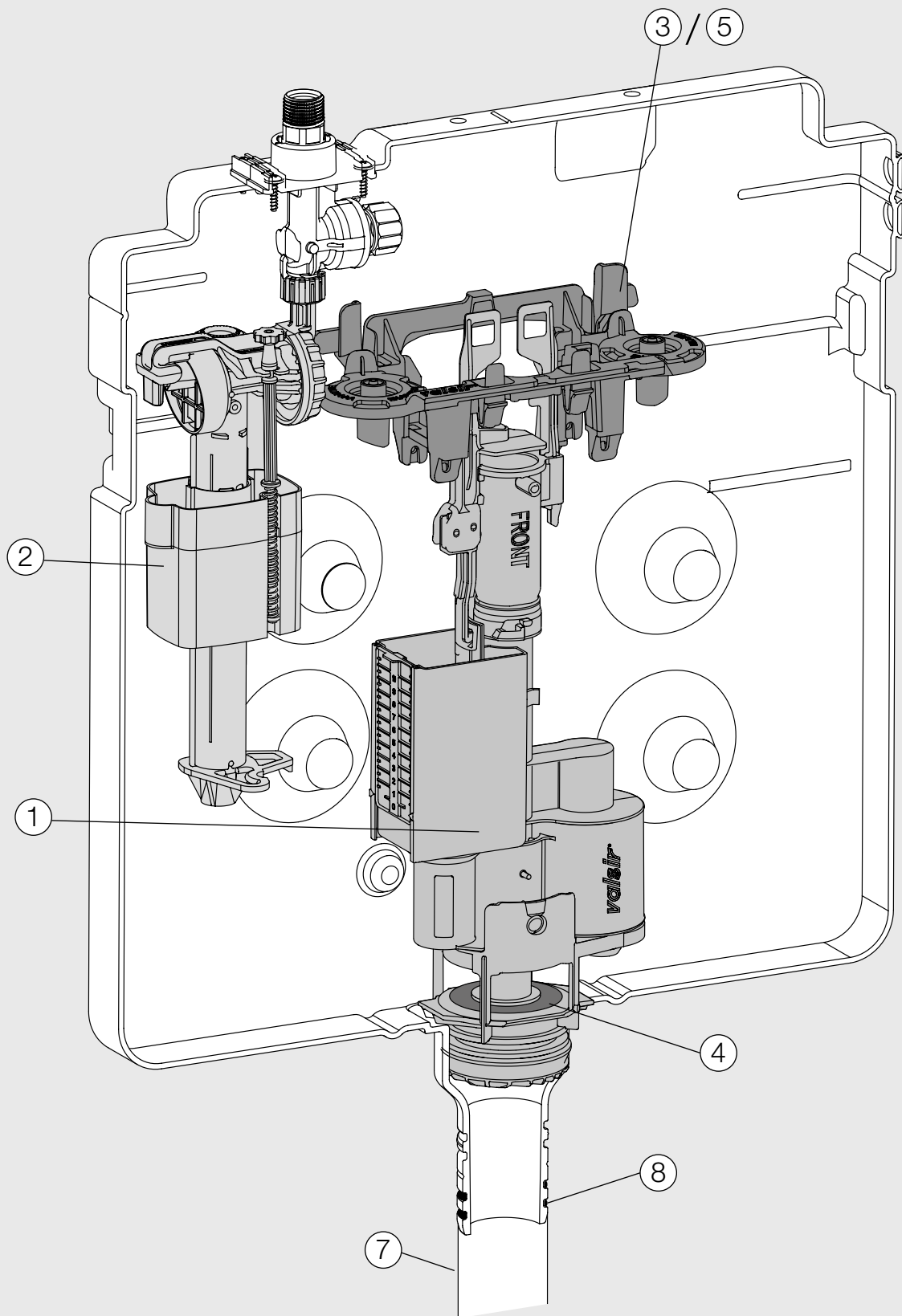



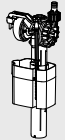
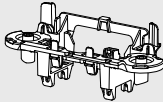

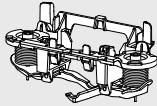
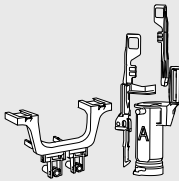
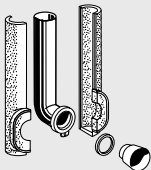



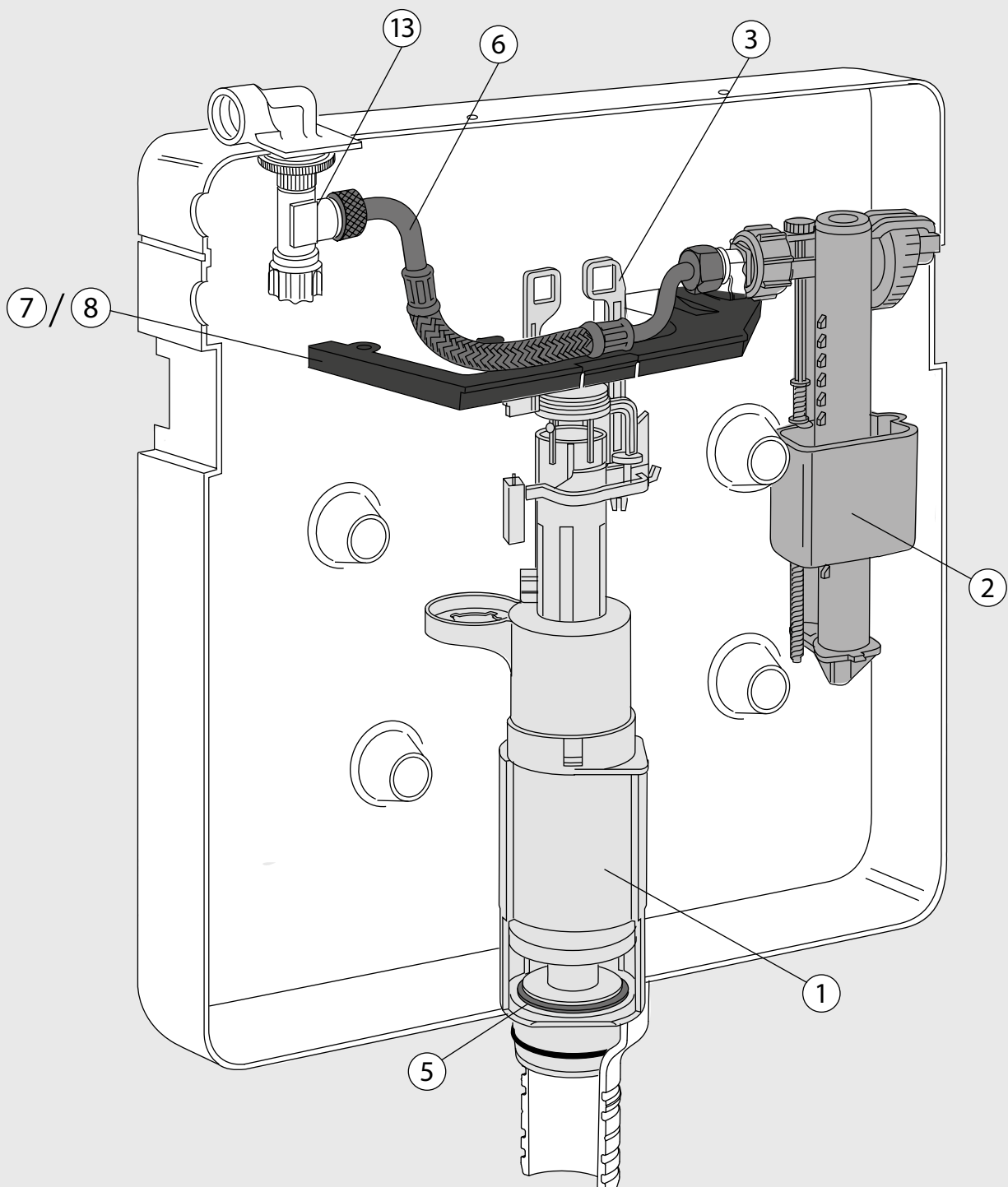

KOD	A	B		CL	pln/szt
VS0868301 •	G1/2" F	G3/8" F	1	SP02	40,09

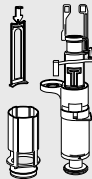
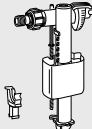
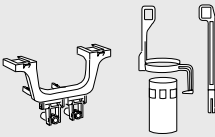
• Wyprzedaż. - Sell out. - Fin de stock.



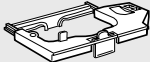
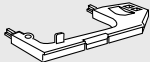



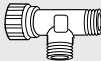

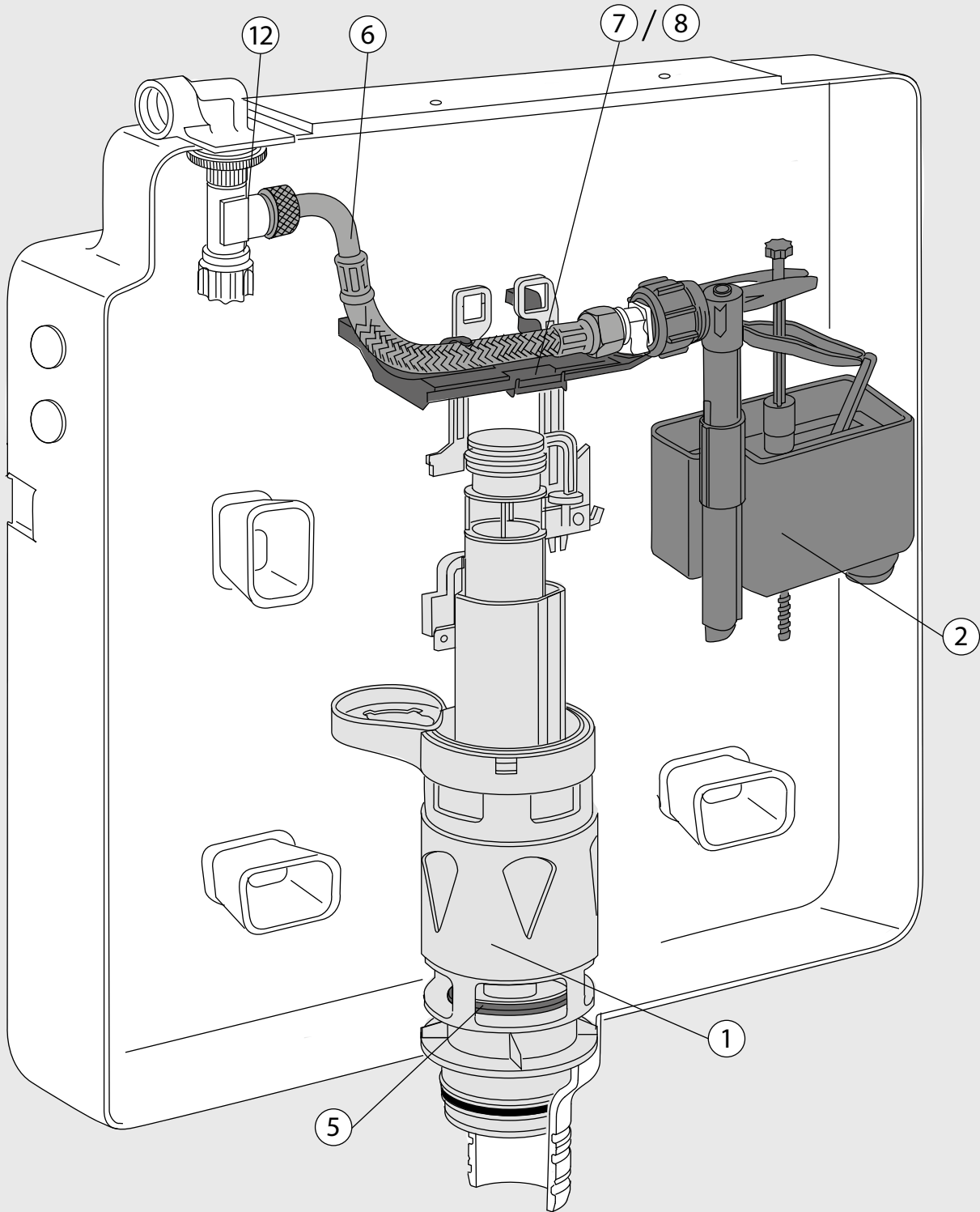

2012-2015			KOD		CL	pln/szt
①		Tropea3 zawór opróżniający Tropea3 mechanical valve Vanne pour Tropea3 mécanique	VS0866690	1	SP02	147,03
②		Zawór napełniający Compact float valve Robinet flotteur Compact	VS0866693	1	SP02	121,61
③		Blokada centralna Central block Bloc central	VS0866694	1	SP02	32,39
④		Uszczelka zaworu opróżniającego Washer for outlet valve Joint de mécanisme	VS0866603	10	SP02	10,24
⑤		Zestaw modyfikujący model mechaniczny na pneumatyczny Mechanical to pneumatic conversion kit Kit de commutation de mécanique à pneumatique	VS0866692	1	SP02	172,93
⑥		Zestaw modyfikujący model pneumatyczny na mechaniczny Pneumatic to mechanical conversion kit Kit de commutation de pneumatique à mécanique	VS0866696	1	SP02	69,60
Kompletny zestaw części zamiennych Complete set spare parts - Jeu complet de pièces de rechange (1+2+3+4+5+6)			VS0866699	1	SP02	530,42
⑦		Zestaw z rurą spustową Tropea3 Flush pipe kit for Tropea3 Kit tuyau de rinçage pour Tropea3	VS0866580	1	SP02	73,36
⑧		O-ring do rury spustowej (2 szt) O-ring for flush pipe (2 pcs) Joint torique pour embout (2 pcs)	VS0820163	1	SP02	13,47
⑨		Uszczelka 2-wargowa do rury spustowej 2-lip seal for pipe Joint en deux lèvres pour tuyau	VS0820119	1	SP02	7,76

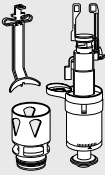
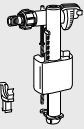

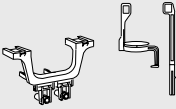

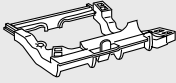
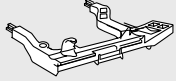

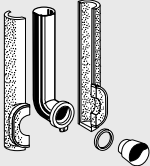

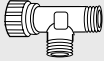
2004-2012		KOD		CL	pln/szt	
①		Zestaw zaworu opróżniającego od 2004 do 2012 Valve kit from 2004 to 2012 Kit vanne de 2004 à 2012	VS0866801	1	SP02	165,34
②		Zestaw zaworu napełniającego od 2004 do 2012 Float valve kit from 2004 to 2012 Kit flotteur de 2004 à 2012	VS0866805	1	SP02	121,61
③		Zestaw modyfikujący model pneumatyczny na mechaniczny Pneumatic to mechanical conversion kit Kit de commutation de pneumatique à mécanique	VS0866803	1	SP02	68,58
④		Zestaw modyfikujący model mechaniczny na pneumatyczny Mechanical to pneumatic conversion kit Kit de commutation de mécanique à pneumatique	VS0866163	1	SP02	177,66
Kompletny zestaw części zamiennych Complete set spare parts - Jeu complet de pièces de rechange (1+2+3+4)			VS0866811	1	SP02	518,46
⑤		Uszczelka zaworu opróżniającego Washer for outlet valve Joint pour vanne	VS0801017	10	SP02	10,24
⑥		Rura giętka 3/8"x3/8" Tropea od 2004 do 2012 Flexible hose 3/8"x3/8" Tropea from 2004 to 2012 Tuyau flexible 3/8"x3/8" Tropea de 2004 à 2012	VS0866118	1	SP02	107,09
⑦		Blokada centralna od 2008 do 2012 Central block from 2008 to 2012 Bloc central de 2008 à 2012	VS0866116	1	SP02	33,59
⑧		Blokada centralna od 2004 do 2007 Central block from 2004 to 2007 Bloc central de 2004 à 2007	VS0866112	1	SP02	80,10
⑨		Zaczep do demontażu gniazda zaworu opróżniającego Hook for guide removal Crochet extraction regard	VS0805153	1	SP02	82,16
⑩		Uchwyt zaworu napełniającego Hook for securing float valve Crochet blocage flotteur	VS0820111	1	SP02	10,24
⑪		Uszczelka 2-wargowa do rury spustowej 2-lip seal for pipe Joint en deux lèvres pour tuyau	VS0820119	1	SP02	7,76
⑫		Skrzynka ochronna Protective case Boîtier de protection	VS0863165	1	SP02	88,45
⑬		Zawór odcinający G3/8" M Stop valve G3/8" M Robinet d'arrêt G3/8" M	VS0868339	1	SP02	70,97

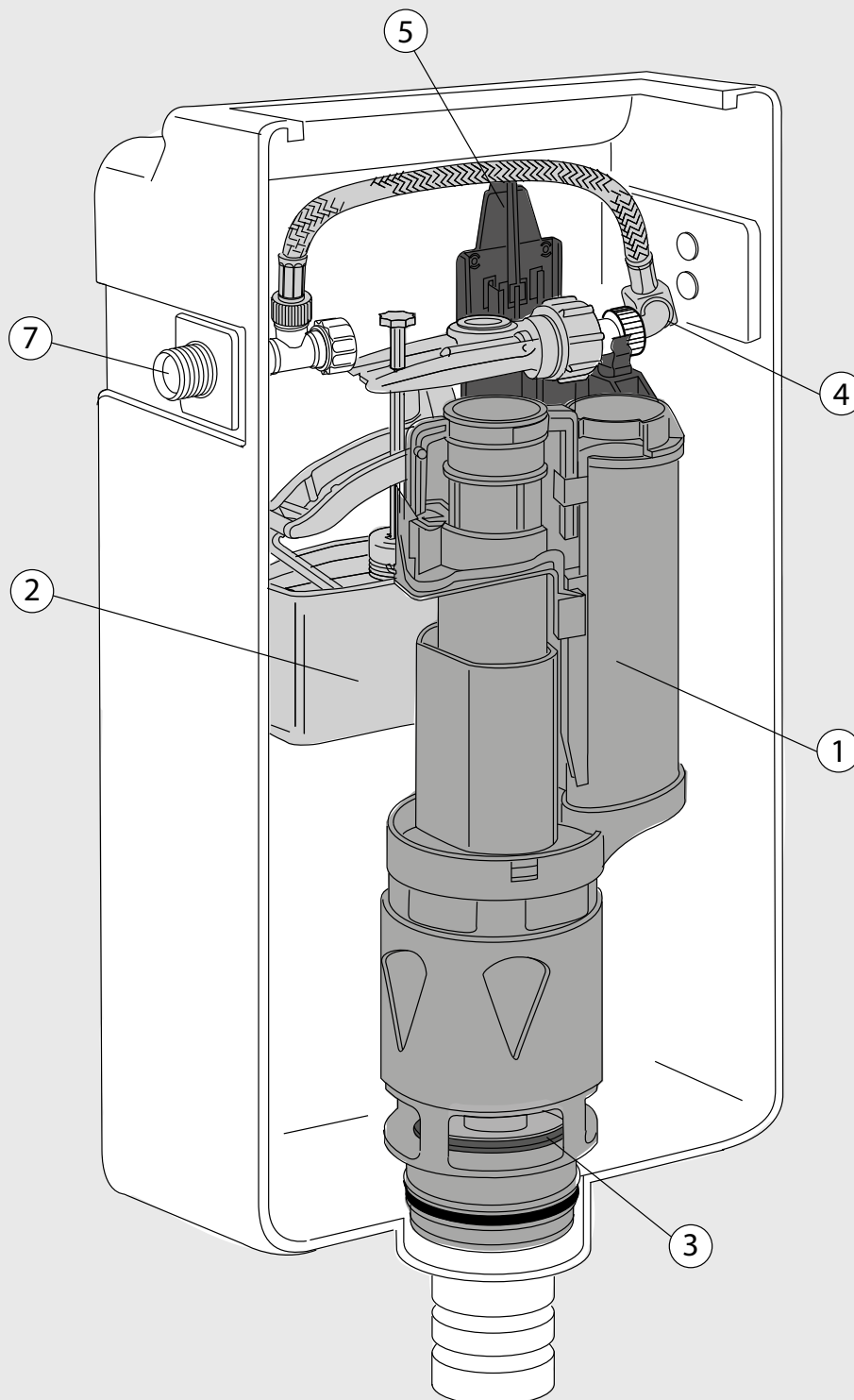



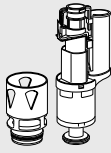
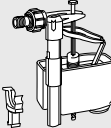

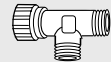

2004-2016

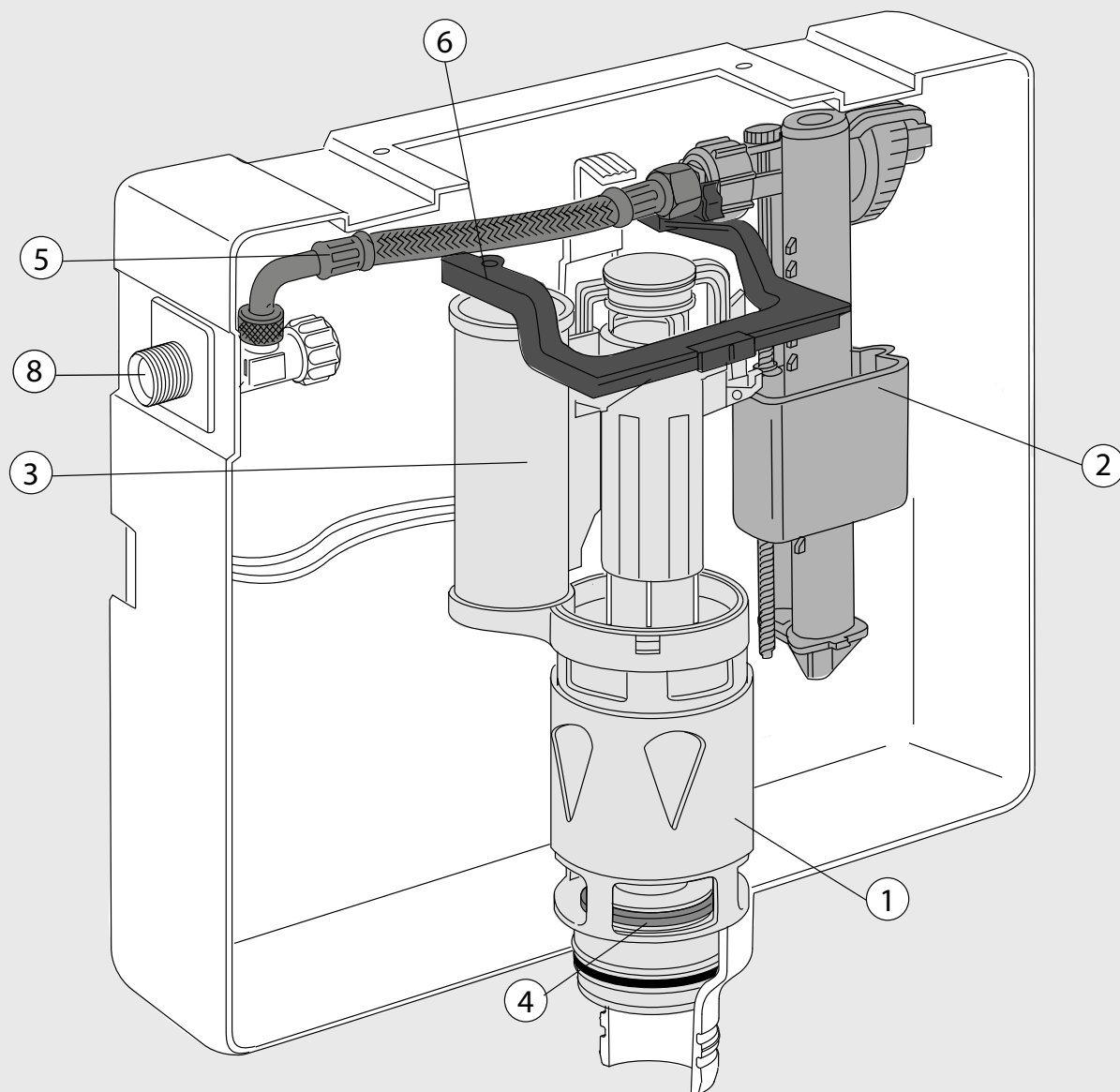
		KOD		CL	pln/szt	
①		Zestaw zaworu opróżniającego od 2004 do 2016 Valve kit from 2004 to 2016 Kit vanne de 2004 à 2016	VS0863851	1	SP02	165,34
②		Zestaw zaworu napełniającego od 2004 do 2016 Float valve kit from 2004 to 2016 Kit flotteur de 2004 à 2016	VS0866805	1	SP02	121,61
③		Zestaw modyfikujący model mechaniczny na pneumatyczny Mechanical to pneumatic conversion kit Kit de commutation de mécanique à pneumatique	VS0863160	1	SP02	177,66
④		Zestaw modyfikujący model pneumatyczny na mechaniczny Pneumatic to mechanical conversion kit Kit de commutation de pneumatique à mécanique	VS0863854	1	SP02	66,60
Kompletny zestaw części zamiennych Complete set spare parts - Jeu complet de pièces de rechange (1+2+3+4)			VS0863859	1	SP02	513,15
⑤		Uszczelka zaworu opróżniającego Washer for outlet valve Joint de mécanisme	VS0801017	10	SP02	10,24
⑥		Rura giętka 3/8"x3/8" Winner 3/8"x3/8" Winner flexible pipe Tuyau flexible 3/8"x3/8" Winner	VS0863118	1	SP02	85,38
⑦		Blokada centralna od 2008 do 2016 Central block from 2008 to 2016 Bloc central de 2008 à 2016	VS0863120	1	SP02	32,39
⑧		Blokada centralna od 2004 do 2007 Central block from 2004 to 2007 Bloc central de 2004 à 2007	VS0863112	1	SP02	32,39
⑨		Uchwyt zaworu napełniającego Hook for securing float valve Tige de blocage robinet flotteur	VS0820111	1	SP02	10,24
⑩		Zestaw z rurą spustową do Winner Flush pipe kit for Winner Kit tube de descente Winner	VS0863155	1	SP02	69,10
⑪		Uszczelka 2-wargowa do rury spustowej 2-lip seal for pipe Joint en deux lèvres pour tuyau	VS0820119	1	SP02	7,76
⑫		Zawór odcinający G3/8" M Stop valve G3/8" M Robinet d'arrêt G3/8" M	VS0868339	1	SP02	70,97

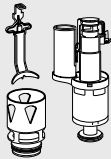
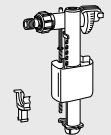
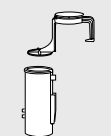

2004-2016		KOD		CL	pln/szt	
①		Zestaw zaworu opróżniającego od 2004 do 2016 Valve kit from 2004 to 2016 Kit vanne de 2004 à 2016	VS0865801	1	SP02	291,93
②		Zestaw zaworu napełniającego od 2004 do 2016 Float valve kit from 2004 to 2016 Kit flotteur de 2004 à 2016	VS0865803	1	SP02	128,65
Kompletny zestaw części zamiennych Complete set spare parts - Jeu complet de pièces de rechange (1+2)			VS0865811	1	SP02	420,62
③		Uszczelka zaworu opróżniającego Washer for outlet valve Joint de mécanisme	VS0801017	10	SP02	10,24
④		Rura giętka 3/8"x3/8" 3/8"x3/8" flexible pipe Tube flexible 3/8"x3/8"	VS0865128	1	SP02	85,38
⑤		Blokada centralna Central block Bloc central	VS0865112	1	SP02	32,39
⑥		Uszczelka 2-wargowa do rury spustowej 2-lip seal for pipe Joint en deux lèvres pour tuyau	VS0820119	1	SP02	7,76
⑦		Zawór odcinający G3/8" M Stop valve G3/8" M Robinet d'arrêt G3/8" M	VS0868339	1	SP02	70,97

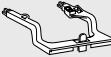

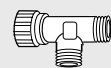
2004-2016		KOD		CL	pln/szt	
①		Zestaw zaworu opróżniającego od 2004 do 2016 Valve kit from 2004 to 2016 Kit vanne de 2004 à 2016	VS0864801	1	SP02	304,33
②		Zestaw zaworu napełniającego od 2004 do 2016 Float valve kit from 2004 to 2016 Kit flotteur de 2004 à 2016	VS0866805	1	SP02	121,61
③		Zestaw pneumatyczny Pneumatic kit Kit pneumatique	VS0863160	1	SP02	177,66
Kompletny zestaw części zamiennych Complete set spare parts - Jeu complet de pièces de rechange (1+2+3)			VS0864811	1	SP02	628,15
④		Uszczelka zaworu opróżniającego Washer for outlet valve Joint de mécanisme	VS0801017	10	SP02	10,24
⑤		Rura giętka 3/8"x3/8" Evolut 3/8"x3/8" Evolut flexible pipe Tube flexible 3/8"x3/8" Evolut	VS0864118	1	SP02	110,70
⑥		Blokada centralna Central block Bloc central	VS0864117	1	SP02	33,66
⑦		Uszczelka 2-wargowa do rury spustowej 2-lip seal for pipe Joint en deux lèvres pour tuyau	VS0820119	1	SP02	7,76
⑧		Zawór odcinający G3/8" M Stop valve G3/8" M Robinet d'arrêt G3/8" M	VS0868339	1	SP02	70,97

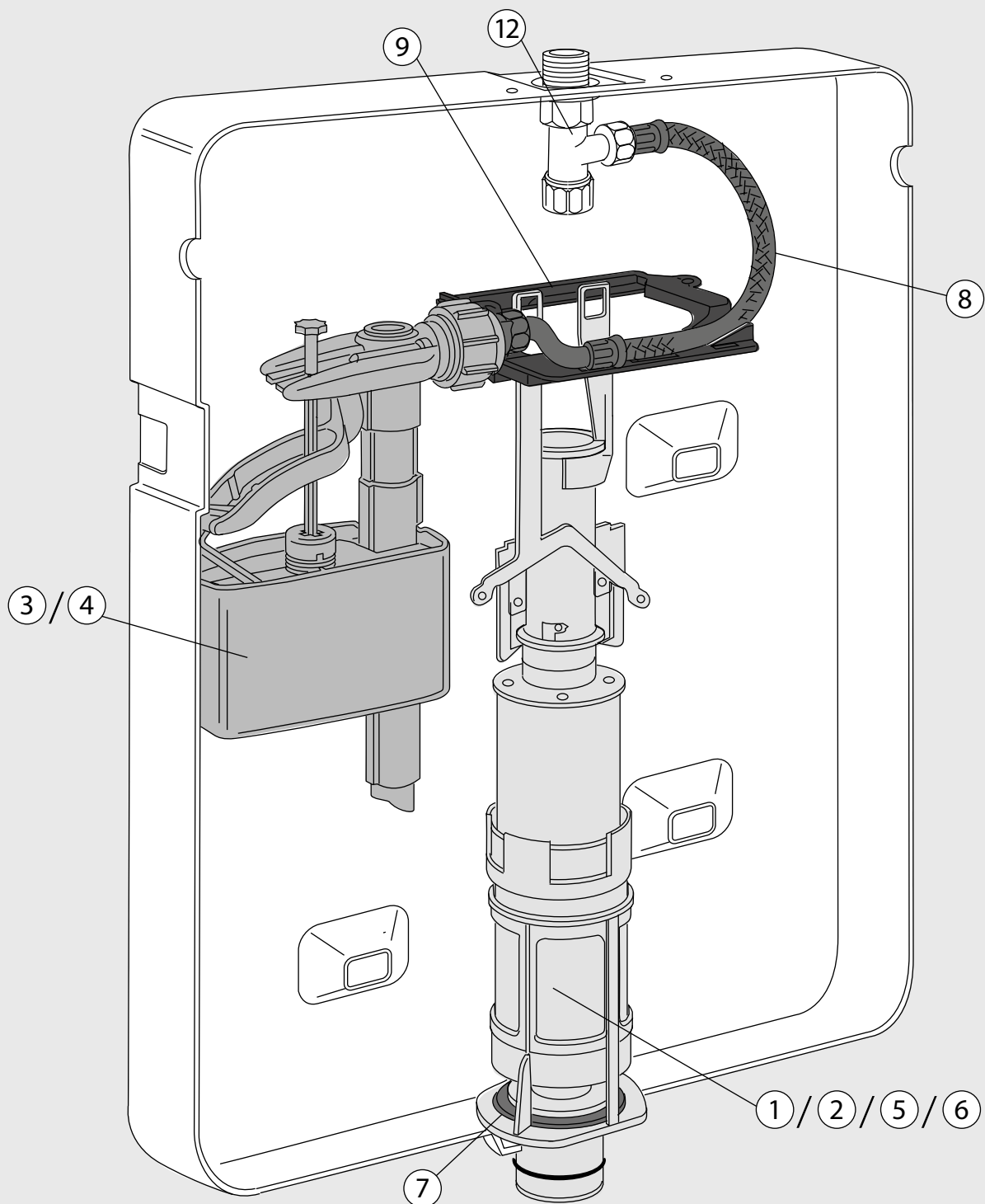

1996-2014			KOD		CL	pln/szt
①		Zestaw zaworu opróżniającego z podwójną objętością spłukiwania od 2000 do 2014 Dual flush valve kit from 2000 to 2014 Kit vanne double évacuation de 2000 à 2014	VS0820802	1	SP02	165,34
②		Zestaw zaworu opróżniającego z pojedynczą objętością spłukiwania od 1996 do 2014 Single flush valve kit from 1996 to 2014 Kit vanne simple évacuation de 1996 à 2014	VS0801802	1	SP02	171,66
③		Zestaw zaworu napełniającego od 1996 do 2007 Dual flush float valve kit from 1996 to 2007 Kit flotteur de 1996 à 2007	VS0866900	1	SP02	128,65
④		Zestaw zaworu napełniającego od 2008 do 2014 Dual flush float valve kit from 2008 to 2014 Kit flotteur de 2008 à 2014	VS0866805	1	SP02	121,61
⑤		Zestaw modyfikujący na model mechaniczny z podwójną objętością spłukiwania Dual flush mechanical conversion kit Kit transformation mécanique double évacuation	VS0820805	1	SP02	187,59
⑥		Zestaw modyfikujący model mechaniczny na pneumatyczny Mechanical to pneumatic conversion kit Kit de commutation de mécanique à pneumatique	VS0820806	1	SP02	256,54
⑦		Uszczelka zaworu opróżniającego Washer for outlet valve Joint pour vanne	VS0801017	10	SP02	10,24
⑧		Rura giętka z uszczelką Flexible pipe with seal Tuyau flexible avec joint incorporé	VS0820096	1	SP02	106,25
⑨		Blokada centralna od 2008 do 2014 Block central from 2008 to 2014 Bloc central de 2008 à 2014	VS0820260	1	SP02	32,39
⑩		Uchwyt zaworu napełniającego Bracket for fixing float valve Élément de fixation flotteur	VS0820378	1	SP02	23,91
⑪		Uszczelka 2-wargowa do rury spustowej 2-lip seal for pipe Joint en deux lèvres pour tuyau	VS0820119	1	SP02	7,76
⑫		Zawór odcinający G1/2" x 3/8" M Stop valve G1/2" x 3/8" M Robinet d'arrêt G1/2" x 3/8" M	VS0820209	1	SP02	82,74

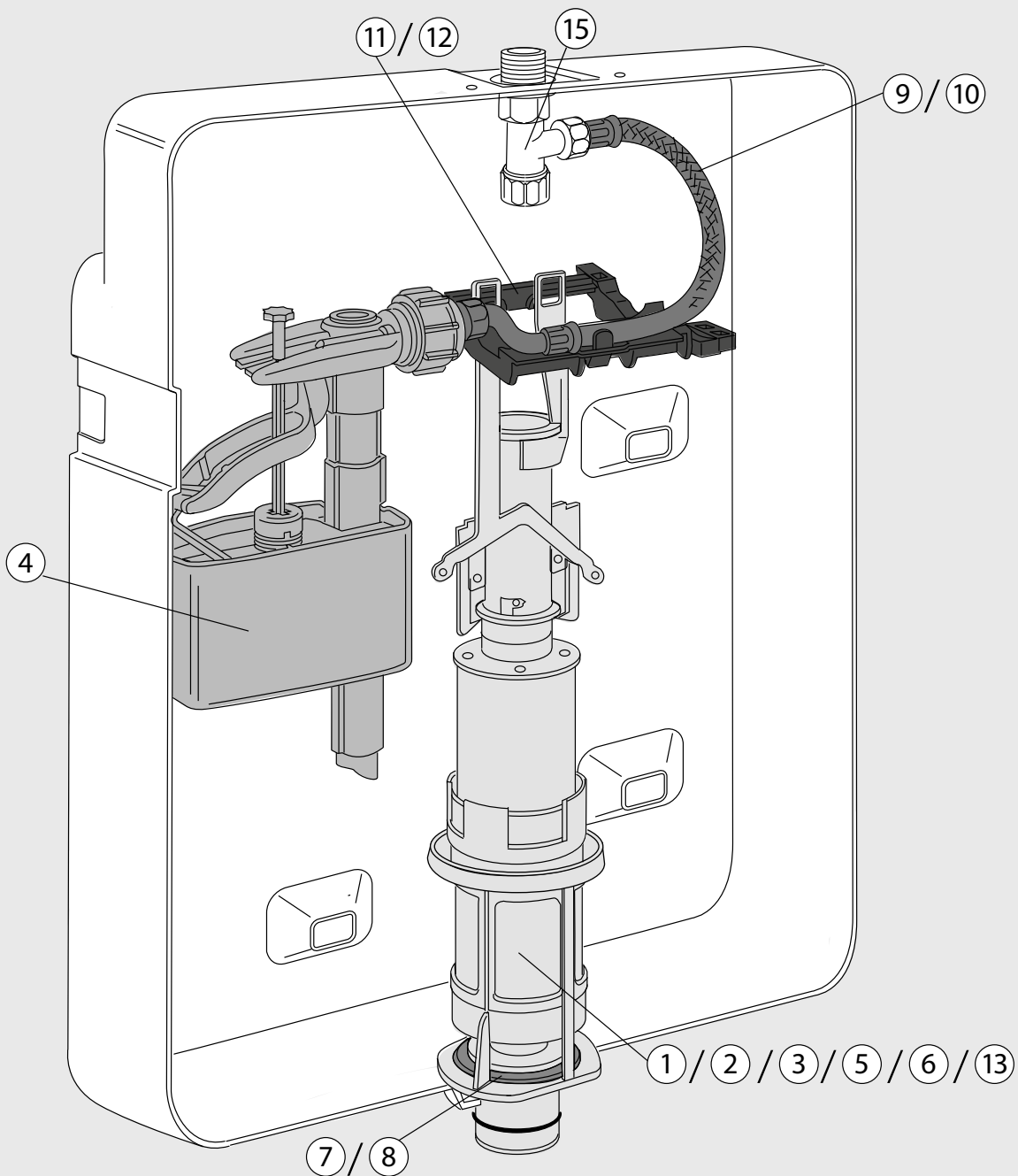

1996-2014

KOD



CL

pln/szt

①



Zestaw zaworu opróżniającego z pojedynczą objętością
spłukiwania od 1996 do 1999
Single flush valve kit from 1996 to 1999
Kit vanne simple évacuation de 1996 à 1999

VS0821802

1

SP02

128,65

②

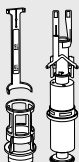







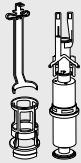
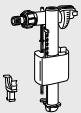
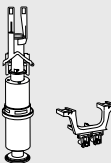

Zestaw zaworu opróżniającego z podwójną objętością
spłukiwania od 2000 do 2009
Dual flush valve kit from 2000 to 2009
Kit vanne double évacuation de 2000 à 2009

VS0821801

1

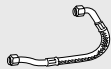
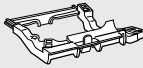
SP02

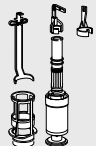
165,34

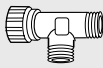

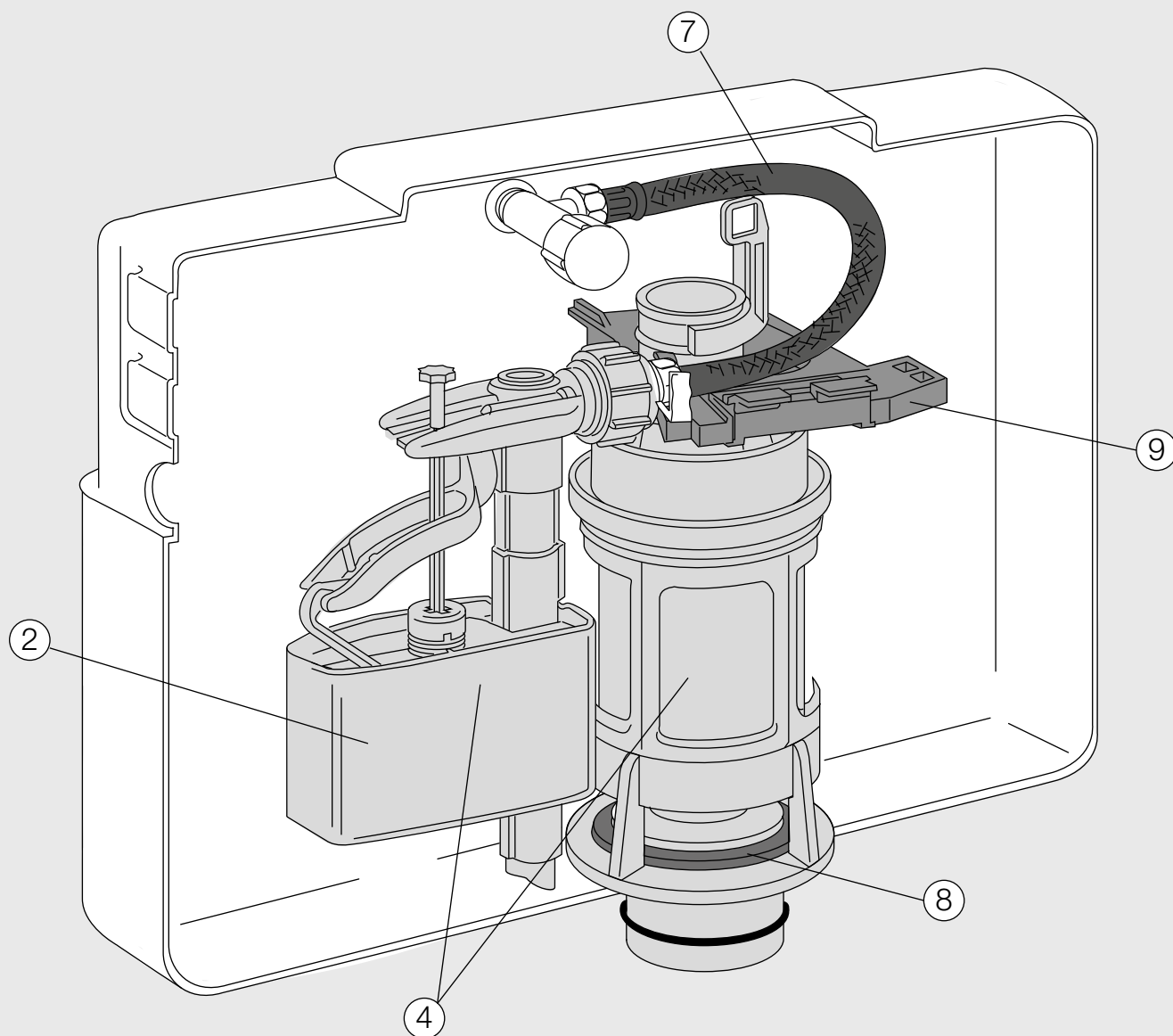
1996-2014			KOD		CL	pln/szt
③		Zestaw zaworu opróżniającego od 2010 do 2014 Valve kit from 2010 to 2014 Kit vanne de 2010 à 2014	VS0821803	1	SP02	165,34
④		Zestaw zaworu napełniającego od 1996 do 2014 Float valve kit from 1996 to 2014 Kit flotteur de 1996 à 2014	VS0866805	1	SP02	121,61
⑤		Zestaw modyfikujący na model mechaniczny z podwójną objętością spłukiwania od 2000 do 2014 Dual flush mechanical conversion kit from 2000 to 2014 Kit transformation mécanique double évacuation de 2000 à 2014	VS0821805	1	SP02	170,12
⑥		Zestaw modyfikujący na model pneumatyczny z pojedynczą objętością spłukiwania od 2000 do 2014 Single flush pneumatic conversion kit from 2000 to 2014 Kit pneumatique simple évacuation de 2000 à 2014	VS0821807	1	SP02	256,54
Kompletny zestaw części zamiennych Complete set spare parts - Jeu complet de pièces de rechange (1+2+3+4+5+6)			VS0821813	1	SP02	985,71
⑦		Uszczelka zaworu opróżniającego od 1996 do 1999 Washer for outlet valve from 1996 to 1999 Joint pour vanne de 1996 à 1999	VS0801065	10	SP02	10,24
⑧		Uszczelka zaworu opróżniającego od 2000 do 2014 Washer for outlet valve from 2000 to 2014 Joint pour vanne de 2000 à 2014	VS0801017	10	SP02	10,24
⑨		Rura giętka z uszczelką od 1996 do 1999 Flexible hose with seal from 1996 to 1999 Tuyau flexible avec joint incorporé de 1996 à 1999	VS0820207	1	SP02	66,10
⑩		Rura giętka z uszczelką od 2000 do 2014 Flexible pipe with seal Tuyau flexible avec joint incorporé	VS0820096	1	SP02	106,25
⑪		Blokada centralna od 2010 do 2014 Central block from 2010 to 2014 Bloc central de 2010 à 2014	VS0863120	1	SP02	32,39
⑫		Blokada centralna od 2000 do 2009 Central block from 2003 to 2009 Bloc central de 2000 à 2009	VS0820369	1	SP02	32,39
⑬		Zestaw zaworu opróżniającego z pojedynczą objętością spłukiwania od 2000 do 2014 Single flush valve kit from 2000 to 2014 Kit vanne simple évacuation de 2000 à 2014	VS0821808	1	SP02	141,18
⑭		Uszczelka 2-wargowa do rury spustowej 2-lip seal for pipe Joint en deux lèvres pour tuyau	VS0820119	1	SP02	7,76
⑮		Zawór odcinający G1/2" x 3/8" M Stop valve G1/2" x 3/8" M Robinet d'arrêt G1/2" x 3/8" M	VS0820209	1	SP02	82,74





1996-2003

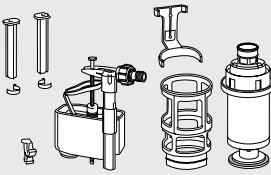

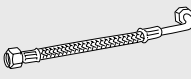
			KOD		CL	pln/szt
①		Zestaw zaworu opróżniającego od 1996 do 2003 Valve kit from 1996 to 2003 Kit vanne de 1996 à 2003	VS0827801	1	SP02	117,31
②		Zestaw zaworu napełniającego od 1996 do 2010 Dual flush float valve kit from 1996 to 2010 Kit flotteur de 1996 à 2010	VS0866805	1	SP02	121,61
③		Wspornik dźwigni cięgieł Lever kit Kit leviers	VS0827808	1	SP02	43,52
Zestaw części zamiennych - Set spare parts - Jeu de pièces de rechange (1+2+3)			VS0827811	1	SP02	261,56

2003-2010

			KOD		CL	pln/szt
④		Zestaw części od 2003 do 2010 Cistern kit from 2003 to 2010 Kit réservoir de 2003 à 2010	VS0827802	1	SP02	270,12
⑤		Zestaw modyfikujący model mechaniczny na pneumatyczny od 2003 do 2010 Mechanical to pneumatic conversion kit from 2003 to 2010 Kit de commutation de mécanique à pneumatique de 2003 à 2010	VS0822909	1	SP02	142,19
⑥		Wspornik dźwigni cięgieł Lever kit Kit leviers	VS0827808	1	SP02	43,52
⑦		Rura giętka dla modeli od 2003 do 2010 Flexible hose for models from 2003 to 2010 Flexible pour modèles de 2003 à 2010	VS0824111	1	SP02	63,82
Zestaw części zamiennych - Set spare parts - Jeu de pièces de rechange (4+5+6+7)			VS0827812	1	SP02	486,21
Kompletny zestaw części zamiennych Complete set spare parts - Jeu complet de pièces de rechange (1+2+3+4+5+6+7)			VS0827813	1	SP02	737,83

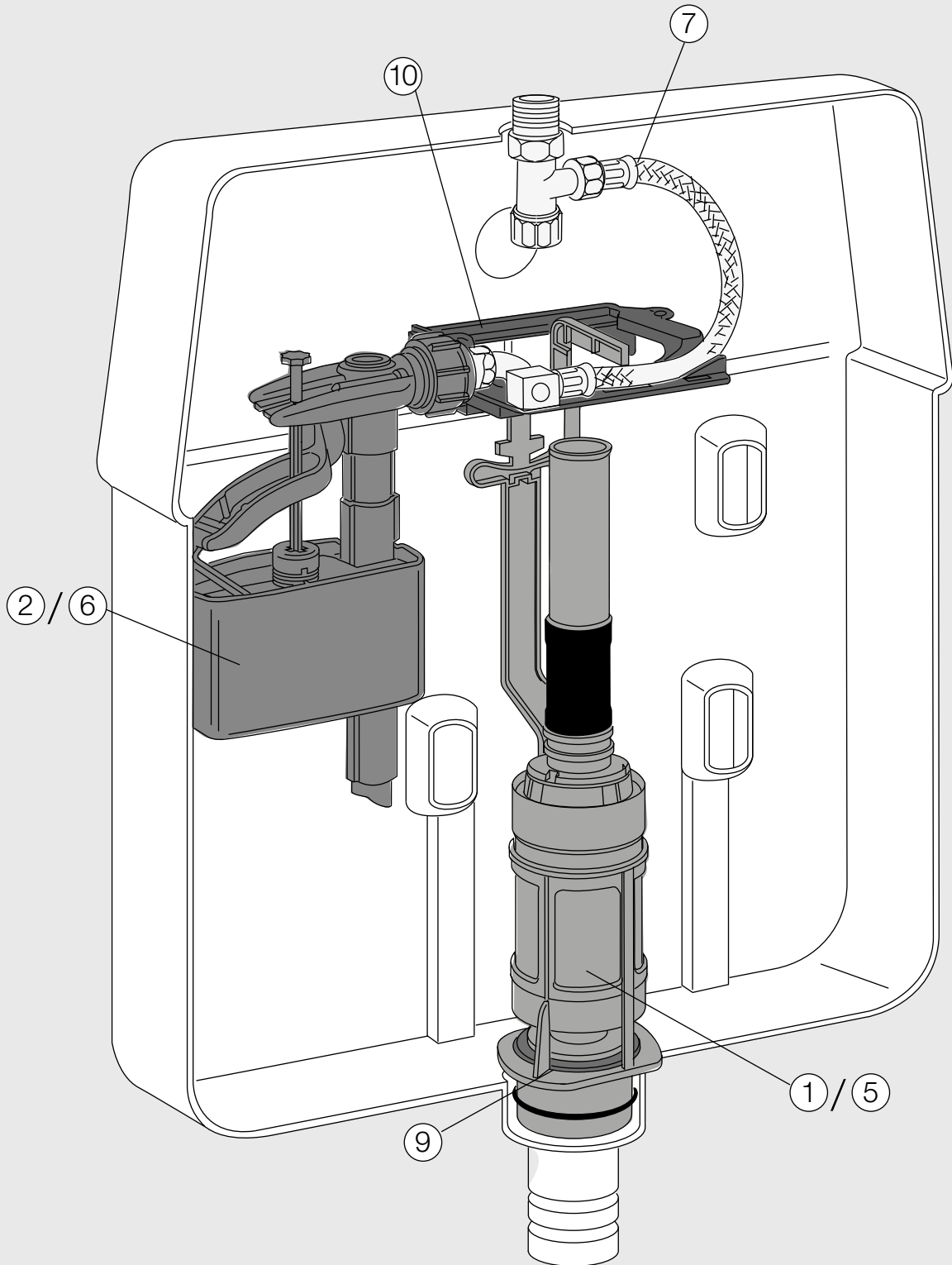
⑧		Uszczelka zaworu opróżniającego Washer for outlet valve Joint pour vanne	VS0801017	10	SP02	10,24
⑨		Blokada centralna Central block Bloc central	VS0823174	1	SP02	48,32
⑩		Uszczelka 2-wargowa do rury spustowej 2-lip seal for pipe Joint en deux lèvres pour tuyau	VS0820119	1	SP02	7,76

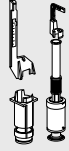
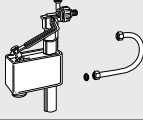
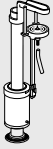

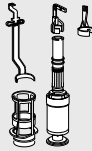
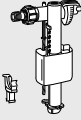
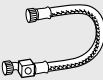
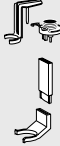
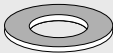
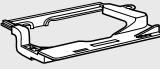
1994-2008			KOD		CL	pln/szt
①		Zestaw zaworu opróżniającego od 1994 do 2008 Valve kit from 1994 to 2008 Kit vanne de 1994 à 2008	VS0801801	1	SP02	151,26
②		Zestaw zaworu napełniającego od 1994 do 2008 Float valve kit from 1994 to 2008 Kit flotteur de 1994 à 2008	VS0801805	1	SP02	171,66
③		Zestaw pneumatyczny od 1994 do 2008 Pneumatic cistern kit from 1994 to 2008 Kit pneumatique réservoir de 1994 à 2008	VS0804660	1	SP02	210,57
④		Manszet do zbiornika od 1994 do 2008 Grommet from 1994 to 2008 Joint de 1994 à 2008	VS0802016	10	SP02	11,88
Zestaw części zamiennych - Set spare parts - Jeu de pièces de rechange (1+2+3+4)			VS0801811	1	SP02	545,04
2009-2010			KOD		CL	pln/szt
⑤		Zestaw zaworu opróżniającego od 2009 do 2010 Valve kit from 2009 to 2010 Kit vanne de 2009 à 2010	VS0801802	1	SP02	171,66
⑥		Zestaw zaworu napełniającego od 2009 do 2010 Float valve kit from 2009 to 2010 Kit flotteur de 2009 à 2010	VS0866805	1	SP02	121,61
⑦		Rurka giętka dla modeli od 2009 do 2010 Flexible hose for models from 2009 to 2010 Flexible pour modèles de 2009 à 2010	VS0820096	1	SP02	106,25
⑧		Zestaw pneumatyczny od 2009 do 2010 Pneumatic cistern kit from 2009 to 2010 Kit pneumatique réservoir de 2009 à 2010	VS0822907	1	SP02	159,06
Zestaw części zamiennych - Set spare parts - Jeu de pièces de rechange (5+6+7+8)			VS0801812	1	SP02	552,63
Kompletny zestaw części zamiennych Complete set spare parts - Jeu complet de pièces de rechange (1+2+3+4+5+6+7+8)			VS0801813	1	SP02	1 098,80
⑨		Uszczelka zaworu opróżniającego Washer for outlet valve Joint pour vanne	VS0801017	10	SP02	10,24
⑩		Blokada centralna Central block Bloc central	VS0820260	1	SP02	32,39

VS08700XX - VS08703XX
WINNER - TROPEA2 MEC

KOD  CL pln/szt

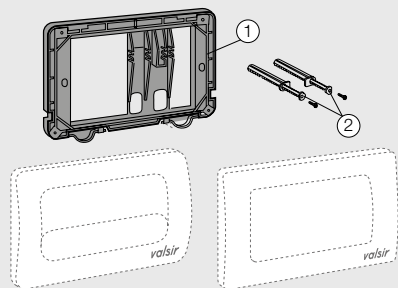

① Ramka montażowa ze śrubami i dystansami
Plate support frame complete with screws and spacers
Contreplaque, vis et entretoises
VS0870847 1 SP02 90,73

② Dystanse do montażu ramki przycisku
Spacer for attaching plate
Entretoises de fixation plaque
VS0864166 1 SP02 18,42

VS08716XX - VS08706XX

TROPEA3 - CUBIK - EVOLUT PNEU - WINNER - TROPEA2 PNEU

KOD  CL pln/szt

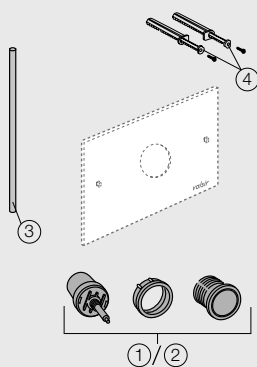

① Zestaw popychacza dla całości spłukiwania chrom połysk
Full flush button kit polished chrome
Kit poussoir de commande débit total - chromé brillant
VS0875313 1 SP02 192,50

② Zestaw popychacza dla całości spłukiwania chrom matowy
Full flush button kit satin chrome
Kit poussoir de commande débit total - chromé mat
VS0875317 1 SP02 192,50

③ Wężyk PVC biały Ø 6x4 - 360 mm
White PVC pipe Ø 6x4 - 360 mm
Tube PVC blanc Ø 6x4 - 360 mm
VS0804697 1 SP02 9,46

④ Dystanse do montażu ramki przycisku
Spacer for attaching plate
Entretoises de fixation plaque
VS0864166 1 SP02 18,42

VS08723XX

KOD  CL pln/szt

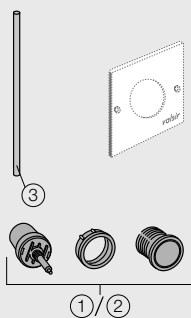

① Zestaw popychacza dla całości spłukiwania chrom połysk
Full flush button kit polished chrome
Kit poussoir de commande débit total - chromé brillant
VS0875313 1 SP02 192,50

② Zestaw popychacza dla całości spłukiwania chrom matowy
Full flush button kit satin chrome
Kit poussoir de commande débit total - chromé mat
VS0875317 1 SP02 192,50

⑤ Wężyk PVC biały Ø 6x4 - 360 mm
White PVC pipe Ø 6x4 - 360 mm
Tube PVC blanc Ø 6x4 - 360 mm
VS0804697 1 SP02 9,46

VS08285XX-VS0828801-VS08280XX-VS0828301
RIOS - ANGEL MEC

KOD



CL

pln/szt

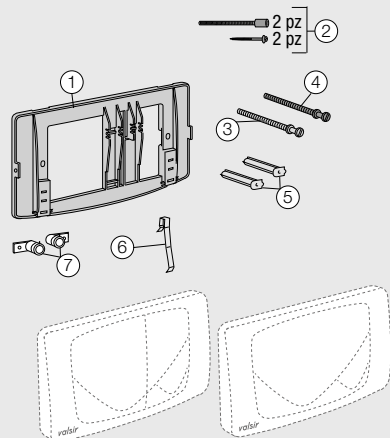

①	Ramka montażowa ze śrubami i dystansami Plate support frame complete with screws and spacers Contreplaque, vis et entretoises	VS0828548	1	SP02	79,13
②	Zestaw przedłużający mocowania przycisku dla pojedynczego spłukiwania Extension kit for fixing plate Kit de rallonge fixation plaque	VS0820222	1	SP02	51,72
③	Popychacz opróżniania całkowitego Screw for push plate, total flush Vis de commande évacuation totale	VS0820110	1	SP02	9,18
④	Popychacz dla 1/2 opróżniania Movement screw for 1/2 flush Vis de mouvement 1/2 évacuation	VS0820367	1	SP02	7,87
⑤	Dystanse do montażu płytki przycisku Spacer for attaching plate Entretoises de fixation plaque	VS0820167	1	SP02	19,08
⑥	Sprężyna Spring Ressort	VS0822127	1	SP02	9,07
⑦	Wsporniki z pierścieniami do regulacji mocowania Support with adjustment ring fixing Support avec bague de réglage fixation	VS0820169	1	SP02	24,70

VS08220XX
 RIOS - ANGEL MEC

		KOD		CL	pln/szt
	①	Ramka montażowa Plate support frame with pawls Contreplaque avec cliquets	VS0804103	1	SP02 50,13
	②	Dźwignia opróżniania Lever for push plate Levier commande plaque	VS0822118	1	SP02 11,09
	③	Popychacz opróżniania całkowitego Screw for push plate, total flush Vis de commande évacuation totale	VS0820110	1	SP02 9,18
	④	Dystanse do montażu ramki przycisku Spacer for attaching plate Entretoises de fixation plaque	VS0820167	1	SP02 19,08
	⑤	Wsporniki z pierścieniami do regulacji mocowania Support with adjustment ring fixing Support avec bague de réglage fixation	VS0820169	1	SP02 24,70

VS08040XX
 MEDUSA MEC

		KOD		CL	pln/szt
	①	Ramka montażowa Plate support frame with pawls Contreplaque avec cliquets	VS0804103	1	SP02 50,13
	②	Dźwignia opróżniania Lever for push plate Levier commande plaque	VS0804050	1	SP02 28,46
	③	Zestaw przedłużający mocowania przycisku Extension kit for fixing plate Kit de rallonge fixation	VS0801068	1	SP02 66,32
	④	Dystanse do montażu ramki przycisku Spacer for attaching plate Entretoises de fixation plaque	VS0820192	1	SP02 25,60
	⑤	Łączniki ramki przycisku (2 szt) Plate fasteners (2 pcs) Éléments de fixation plaque (2 pièces)	VS0801025	1	SP02 43,31

VS08234XX
 EGEA MEC

KOD







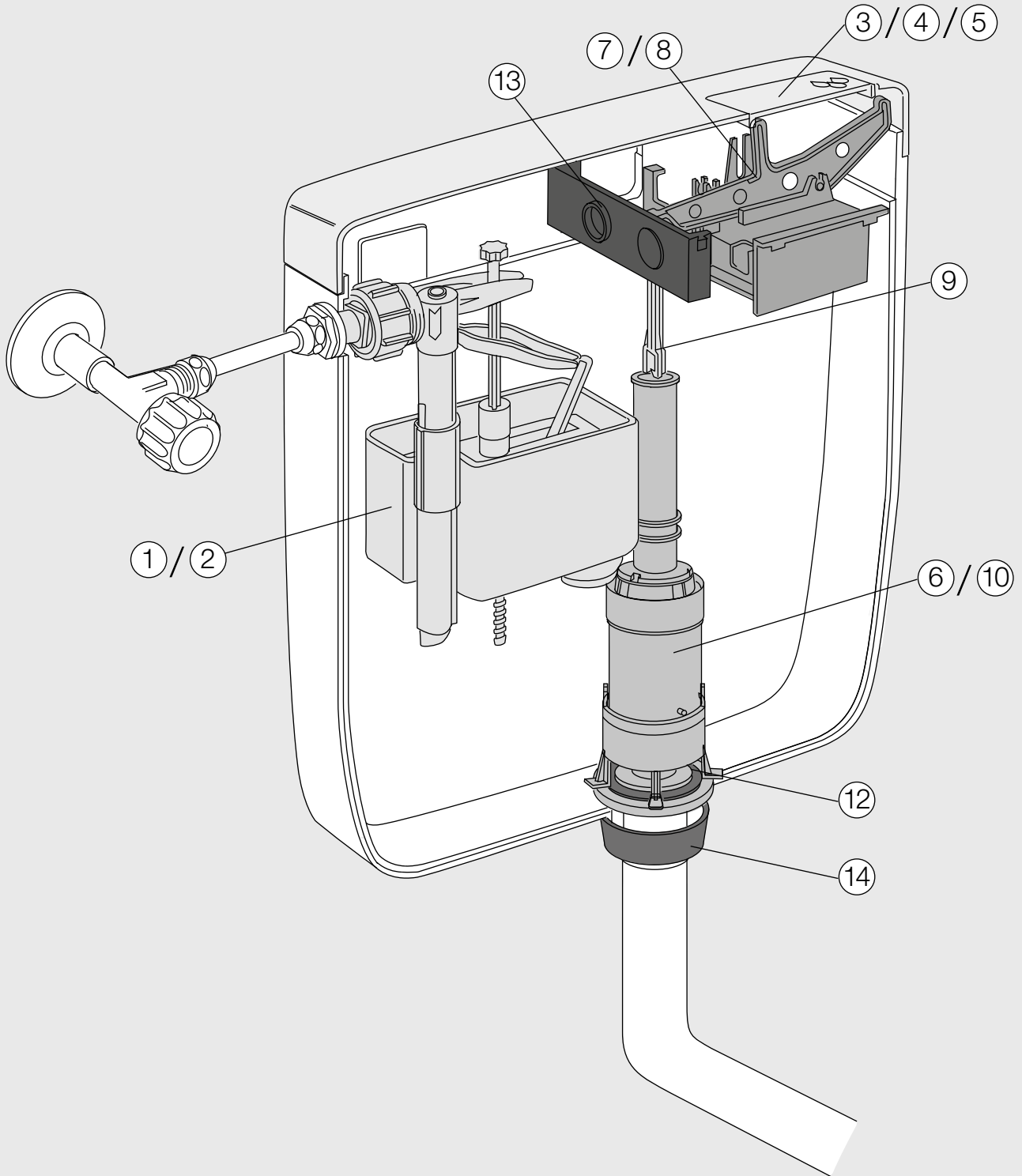

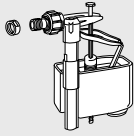
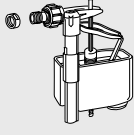
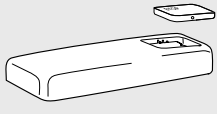
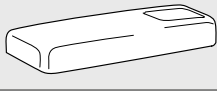
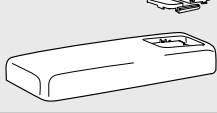

CL pln/szt

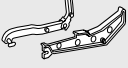
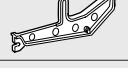
		KOD		CL	pln/szt
	①	Dźwignia opróżniania Lever for push plate Lever commande plaque	VS0823685	1	SP02 11,66
	②	Zaczep dźwigni opróżniania Control lever Lever de mouvement	VS0823021	1	SP02 13,33
	③	Popychacz opróżniania Screw for control mechanism Vis de mouvement	VS0823020	1	SP02 14,63
	④	Dystanse do montażu przycisku Spacer for attaching plate Entretoises de fixation plaque	VS0820191	1	SP02 24,67



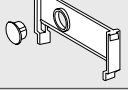

Części zamienne - Spare parts - Pièces de rechange

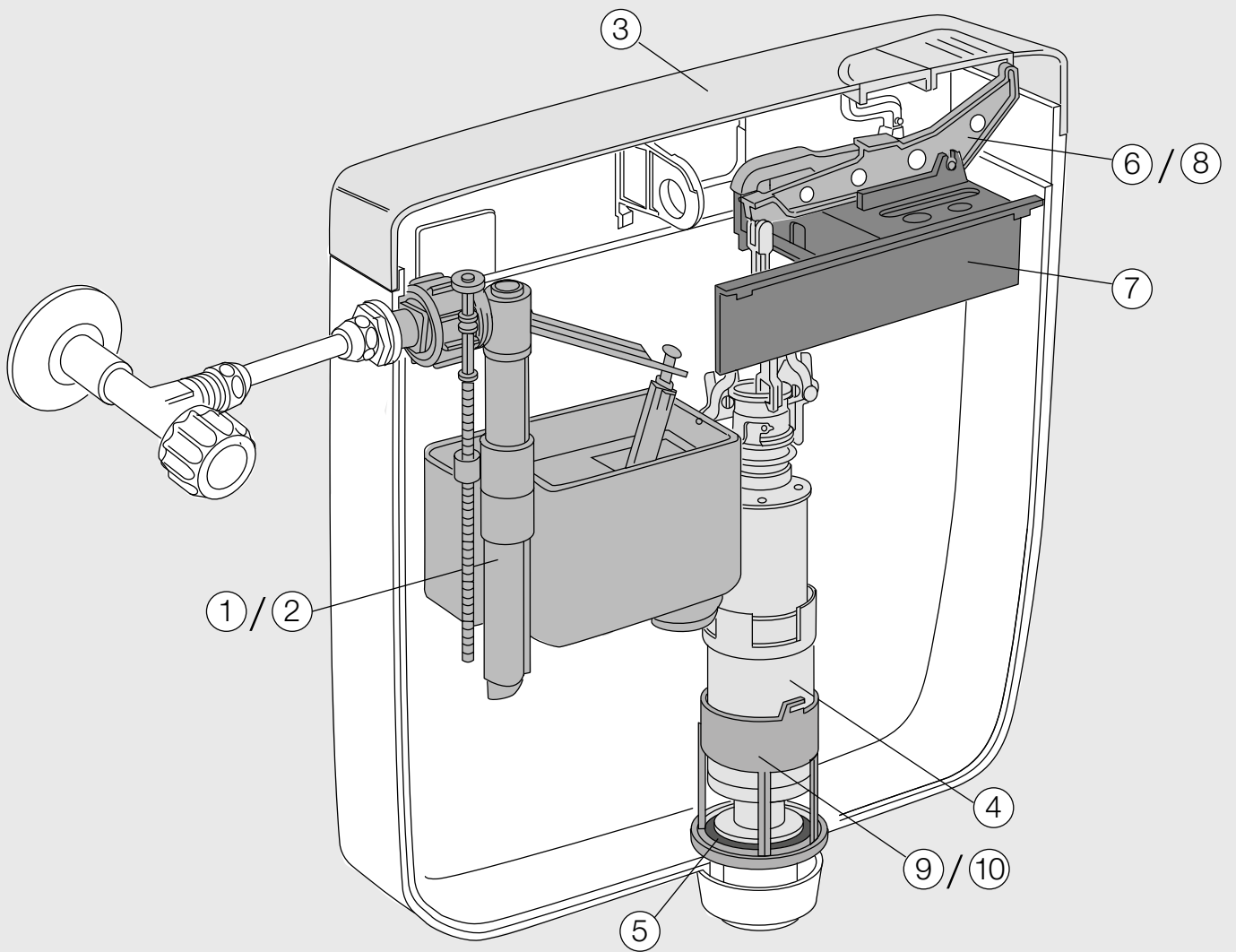
		KOD		CL	pln/szt	
①		Zawór napełniający 3/8" Mono 3/8" Mono float valve Robinet flotteur 3/8" Mono	VS0800218	1	SP02	105,75
②		Zawór napełniający 1/2" Mono 1/2" Mono float valve Robinet flotteur 1/2" Mono	VS0800219	1	SP02	105,75
③		Pokrywa sfluczki Corallo z pojedynczym przyciskiem od 1999 do 2012 Lid for Corallo cistern with single flush button from 1999 to 2012 Couvercle avec poussoir pour réservoir Corallo 1999-2012	VS0814401	1	SP02	80,43
④		Pokrywa sfluczki Corallo z zaślepką dla wesji pneumatycznej Lid for Corallo pneumatic cistern with fixed cap Couvercle pour réservoir Corallo avec partie fixe pour pneumatique	VS0814701	1	SP02	80,43
⑤		Pokrywa sfluczki Corallo z podwójnym przyciskiem. Biała Lid dual flush buttons for Corallo cistern. White Couvercle avec 2 poussoirs pour réservoir Corallo blanc	VS0814201	1	SP02	80,43
⑥		Zawór opróżniający z pojedynczą objętością sflukiwania od 1999 al 2012 Single flush outlet valve from 1999 to 2012 Mécanisme simple debit 1999-2012	VS0810251	1	SP02	79,89
⑦		Zestaw dźwigni opróżniających Kit mechianc levers Kit mécanique leviers	VS0810160	1	SP02	45,73
⑧		Dźwignia pojedynczego opróżniania Single flush levers Lever évacuation partielle	VS0810165	1	SP02	21,17
⑨		Cięgło Anchor Ancre	VS0810108	1	SP02	25,90
⑩		Zawór opróżniający z podwójną objętością sflukiwania, z cięgłem od 1999 do 2012 Dual flush outlet valve, with anchor from 1999 to 2012 Vanne d'évacuation deux quantités avec ancre de 1999 à 2012	VS0810156	1	SP02	124,39
⑪		Mechanizm pneumatyczny Corallo Corallo pneumatic mechanism Mécanisme pneumatique Corallo	VS0804505	1	SP02	159,57
⑫		Uszczelka zaworu opróżniającego Seal for outlet valve Joint de mécanisme	VS0801017	10	SP02	10,24
⑬		Uchwyt mocowania zaworu napełniającego Crosspiece for holding float valve Traverse porte robinet flotteur	VS0850402	1	SP02	23,62
⑭		Duża gwintowana nakrętka z pierścieniem i uszczelką Large threaded nut with ring and seal Ecrou fileté avec anneau et joint	VS0810113	1	SP02	31,68



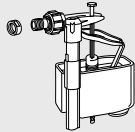
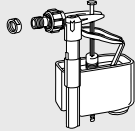
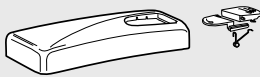

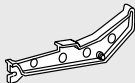
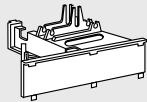
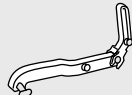
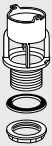
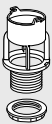
Części zamienne - Spare parts - Pièces de rechange

		KOD		CL	pln/szt
①		Zawór napełniający 3/8" Mono 3/8" Mono float valve Robinet flotteur 3/8" Mono	VS0800218	1	SP02 105,75
②		Zawór napełniający 1/2" Mono 1/2" Mono float valve Robinet flotteur 1/2" Mono	VS0800219	1	SP02 105,75
③		Pokrywa spłuczki z przyciskami Lid with push buttons Couvercle avec poussoirs	VS0831401	1	SP02 250,00
④		Zawór opróżniający z podwójną objętością spłukiwania, z cięgiem i dźwignią opróżniania Dual flush valve with anchor and kit with lever Vanne d'évacuation 2 quantité avec ancre et kit leviers mouvement	VS0810148	1	SP02 124,39
⑤		Uszczelka zaworu opróżniającego Washer for flush valve Joint de mécanisme	VS0801017	10	SP02 10,24
⑥		Dźwignia całkowitego opróżniania Control lever, full flush Lever évacuation totale	VS0810163	1	SP02 22,86
⑦		Blokada centralna dla dźwigni opróżniania Central block for lever Bloc central porte levier	VS0838591	1	SP02 30,02
⑧		Dźwignia częściowego opróżniania Half flush lever Lever évacuation partielle	VS0810164	1	SP02 22,86
⑨		Gniazdo zaworu opróżniającego z nakrętką i uszczelką dla spłuczek kompaktowych Basket with nut and seal for close-coupled cistern Siège avec écrou et joint pour réservoir monobloc	VS0810258	1	SP02 33,19
⑩		Gniazdo zaworu opróżniającego z nakrętką i uszczelką dla spłuczek montowanych w niskim i pośrednim położeniu Basket with nut and seal for low-and medium level cistern Siège avec écrou et joint pour réservoir bas mi haut	VS0810261	1	SP02 33,19

LISTA TOWARÓW
LIST OF PRODUCTS
LISTE DES ARTICLES

KOD	str		CL	pln
VS0334021	116	50	PE02	4,93
VS0335001	116	20	VA02	160,72
VS0335003	116	20	VA02	143,97
VS0337001	118	20	VA02	35,94
VS0354001	96	10	SP02	144,47
VS0364001	93	10	SP02	121,03
VS0364003	93	10	SP02	124,92
VS0364006	93	10	SP02	117,85
VS0364008	93	10	SP02	155,30
VS0364015	93	1	SP02	114,42
VS0364059	93	1	SP02	163,64
VS0364100	93	10	SP02	222,84
VS0364111	93	10	SP02	124,92
VS0364130	95	1	SP02	183,95
VS0366001	96	10	SP02	90,45
VS0366002	96	10	SP02	55,69
VS0366003	96	10	SP02	111,67
VS0366090	95	10	SP02	153,07
VS0366113	95	10	SP02	192,79
VS0366125	95	10	SP02	124,92
VS0366133	95	10	SP02	127,75
VS0366139	97	1	SP02	270,41
VS0366149	97	1	SP02	282,04
VS0367001	96	10	SP02	97,37
VS0367003	96	10	SP02	97,37
VS0368001	94	5	PE02	315,82
VS0368003	94	5	PE02	315,82
VS0370001	94	5	PE02	175,68
VS0370002	94	5	PE02	165,47
VS0370003	94	5	PE02	175,68
VS0372001	94	5	PE02	175,68
VS0372002	94	5	PE02	165,47
VS0372003	94	5	PE02	175,68
VS0374001	93	5	PE02	419,78
VS0374003	93	5	PE02	419,78
VS0391320	116	20	VA02	3,94
VS0564190	97	10	PP02	70,57
VS0587001	97	10	VA02	38,27
VS0700071	97	10	SP01	46,87
VS0700073	98	10	SP01	46,87
VS0700075	98	15	SP01	40,91
VS0700098	116	50	VA02	96,58
VS0700099	116	50	VA02	96,58
VS0800218	191	1	SP02	105,75
VS0800219	191	1	SP02	105,75
VS0801017	191	10	SP02	10,24
VS0801025	186	1	SP02	43,31
VS0801065	179	10	SP02	10,24
VS0801068	186	1	SP02	66,32
VS0801801	183	1	SP02	151,26
VS0801802	183	1	SP02	171,66
VS0801805	183	1	SP02	171,66
VS0801811	183	1	SP02	545,04
VS0801812	183	1	SP02	552,63
VS0801813	183	1	SP02	1 098,80
VS0802009	138	1	SP02	13,47
VS0802016	183	10	SP02	11,88
VS0802135	72	1	SP01	543,67
VS0802137	72	1	SP01	690,32
VS0802235	72	1	SP01	661,58
VS0802237	72	1	SP01	832,14
VS0802301	77	1	SP01	153,31
VS0802335	77	1	SP01	226,29
VS0802337	77	1	SP01	256,79
VS0802401	77	1	SP01	200,44
VS0802435	77	1	SP01	342,36



KOD	str		CL	pln
VS0802437	77	1	SP01	387,68
VS0802455	76	1	SP01	1 846,29
VS0802535	164	1	SP01	290,58
VS0802537	164	1	SP01	370,42
VS0802601	80	10	VA02	48,62
VS0802635	80	10	VA02	104,02
VS0802701	80	10	VA02	53,53
VS0802735	80	10	VA02	109,32
VS0802835	164	1	SP01	371,44
VS0802837	164	1	SP01	474,46
VS0802935	164	1	SP01	312,60
VS0802937	164	1	SP01	395,80
VS0803001	81	1	VA02	41,82
VS0803003	81	1	VA02	41,33
VS0803035	81	1	VA02	118,65
VS0803037	81	1	VA02	140,44
VS0803111	79	1	VA02	41,82
VS0803145	79	1	VA02	122,79
VS0803147	79	1	VA02	140,79
VS0803201	80	1	VA02	42,70
VS0803202	140	1	SP02	32,97
VS0803235	80	1	VA02	118,65
VS0803511	79	1	VA02	54,77
VS0803545	79	1	VA02	127,84
VS0803547	79	1	VA02	147,91
VS0803901	79	1	VA02	78,46
VS0804001	160	5	SP01	171,13
VS0804035	160	5	SP01	331,88
VS0804050	186	1	SP02	28,46
VS0804103	186	1	SP02	50,13
VS0804501	161	1	SP01	135,96
VS0804505	189	1	SP02	159,57
VS0804535	161	1	SP01	214,59
VS0804537	161	1	SP01	198,69
VS0804621	137	1	SP02	98,49
VS0804622	137	1	SP02	187,16
VS0804623	137	1	SP02	249,21
VS0804625	137	1	SP02	27,52
VS0804628	137	1	SP02	41,75
VS0804635	137	1	SP02	41,93
VS0804660	183	1	SP02	210,57
VS0804697	184	1	SP02	9,46
VS0804698	136	1	SP02	9,46
VS0804801	76	1	SP01	553,04
VS0804811	136	1	SP02	154,98
VS0804824	136	1	SP02	20,51
VS0804901	76	1	SP01	794,65
VS0804902	136	1	SP02	198,28
VS0804911	136	1	SP02	308,59
VS0805128	139	1	SP02	31,68
VS0805150	101	1	VA02	469,93
VS0805153	169	1	SP02	82,16
VS0805350	98	1	SP01	90,84
VS0805355	98	1	SP01	90,84
VS0810078	143	1	SP02	129,98
VS0810106	153	1	SP02	22,86
VS0810108	189	1	SP02	25,90
VS0810113	189	1	SP02	31,68
VS0810114	119	1	VA02	108,56
VS0810115	118	1	VA02	45,88
VS0810148	191	1	SP02	124,39
VS0810156	189	1	SP02	124,39
VS0810157	151	1	SP02	22,86
VS0810159	147	1	SP02	28,85
VS0810160	189	1	SP02	45,73
VS0810163	191	1	SP02	22,86



KOD	str		CL	pln
VS0810164	191	1	SP02	22,86
VS0810165	189	1	SP02	21,17
VS0810166	151	1	SP02	22,86
VS0810181	120	1	VA02	131,42
VS0810199	120	1	VA02	125,54
VS0810251	189	1	SP02	79,89
VS0810258	191	1	SP02	33,19
VS0810261	191	1	SP02	33,19
VS0810291	149	1	SP02	85,21
VS0810293	145	1	SP02	85,21
VS0810521	143	10	SP02	14,33
VS0810522	143	1	SP02	84,63
VS0810998	120	1	VA02	125,54
VS0814201	189	1	SP02	80,43
VS0814401	189	1	SP02	80,43
VS0814701	189	1	SP02	80,43
VS0815001	113	1	VA02	50,79
VS0815035	113	1	VA02	76,65
VS0815064	117	1	VA02	87,08
VS0815071	114	1	VA02	167,93
VS0815083	117	5	VA02	60,56
VS0815101	113	1	VA02	40,62
VS0815103	113	1	VA02	40,05
VS0815105	113	1	VA02	40,05
VS0815201	113	1	VA02	38,76
VS0815203	113	1	VA02	38,59
VS0815301	113	1	VA02	83,63
VS0815313	113	1	VA02	80,23
VS0815317	113	1	VA02	80,23
VS0815401	113	1	VA02	111,62
VS0815405	113	1	VA02	109,41
VS0815409	113	1	VA02	109,41
VS0815417	113	1	VA02	109,41
VS0815421	113	1	VA02	109,41
VS0815501	113	1	VA02	127,08
VS0815601	114	1	VA02	111,62
VS0815603	114	1	VA02	109,41
VS0815801	117	1	VA02	52,12
VS0815999	115	1	VA02	108,83
VS0816001	116	10	VA02	14,19
VS0816003	116	10	VA02	14,19
VS0816005	116	10	VA02	14,19
VS0816101	105	5	SP01	485,54
VS0816103	105	5	SP01	423,08
VS0816105	105	5	SP01	443,92
VS0816151	105	5	SP01	509,67
VS0816153	105	5	SP01	578,66
VS0817001	114	1	VA02	35,67
VS0817003	114	1	VA02	32,85
VS0817401	143	1	SP02	147,03
VS0817403	143	1	SP02	45,47
VS0817404	143	1	SP02	80,43
VS0817405	143	1	SP02	80,43
VS0817410	143	1	SP02	112,83
VS0820096	183	1	SP02	106,25
VS0820110	186	1	SP02	9,18
VS0820111	171	1	SP02	10,24
VS0820118	132	1	SP02	16,47
VS0820119	181	1	SP02	7,76
VS0820163	167	1	SP02	13,47
VS0820167	186	1	SP02	19,08
VS0820169	186	1	SP02	24,70
VS0820191	187	1	SP02	24,67
VS0820192	186	1	SP02	25,60
VS0820207	179	1	SP02	66,10
VS0820209	177	1	SP02	82,74



KOD	str		CL	pln
VS0820222	185	1	SP02	51,72
VS0820224	139	1	SP02	99,72
VS0820260	183	1	SP02	32,39
VS0820367	185	1	SP02	7,87
VS0820369	179	1	SP02	32,39
VS0820378	177	1	SP02	23,91
VS0820802	177	1	SP02	165,34
VS0820805	177	1	SP02	187,59
VS0820806	177	1	SP02	256,54
VS0821801	178	1	SP02	165,34
VS0821802	178	1	SP02	128,65
VS0821803	179	1	SP02	165,34
VS0821805	179	1	SP02	170,12
VS0821807	179	1	SP02	256,54
VS0821808	179	1	SP02	141,18
VS0821813	179	1	SP02	985,71
VS0822001	159	5	SP01	173,06
VS0822003	159	5	SP01	160,14
VS0822015	118	1	VA02	51,14
VS0822017	159	5	SP01	160,14
VS0822118	186	1	SP02	11,09
VS0822127	185	1	SP02	9,07
VS0822301	159	5	SP01	216,51
VS0822907	183	1	SP02	159,06
VS0822909	181	1	SP02	142,19
VS0823020	187	1	SP02	14,63
VS0823021	187	1	SP02	13,33
VS0823174	181	1	SP02	48,32
VS0823201	161	5	SP01	240,52
VS0823401	161	5	SP01	178,01
VS0823435	161	5	SP01	332,54
VS0823437	161	5	SP01	360,44
VS0823438	161	5	SP01	436,41
VS0823685	187	1	SP02	11,66
VS0823801	162	1	SP01	135,43
VS0823900	162	1	SP01	268,66
VS0824111	181	1	SP02	63,82
VS0824135	139	1	SP02	27,16
VS0825021	138	1	SP02	20,87
VS0825023	139	10	VA02	63,29
VS0825028	139	10	VA02	61,23
VS0825030	138	1	SP02	51,54
VS0825031	138	1	SP02	76,64
VS0825051	99	10	VA02	10,16
VS0825053	99	10	VA02	10,16
VS0825056	99	10	VA02	11,10
VS0825058	99	10	VA02	11,10
VS0825302	84	1	SP01	785,80
VS0825402	84	1	SP01	797,24
VS0825601	101	1	VA02	362,65
VS0826065	140	1	SP02	28,85
VS0826066	140	1	SP02	33,99
VS0826068	140	1	SP02	54,50
VS0826072	140	1	SP02	28,85
VS0827801	181	1	SP02	117,31
VS0827802	181	1	SP02	270,12
VS0827808	181	1	SP02	43,52
VS0827811	181	1	SP02	261,56
VS0827812	181	1	SP02	486,21
VS0827813	181	1	SP02	737,83
VS0828001	159	5	SP01	183,00
VS0828003	159	5	SP01	160,14
VS0828005	159	5	SP01	160,14
VS0828201	80	1	VA02	27,05
VS0828501	158	5	SP01	201,75
VS0828535	158	5	SP01	378,71

KOD	str		CL	pln
VS0828537	158	5	SP01	409,11
VS0828548	185	1	SP02	79,13
VS0828601	158	5	SP01	255,71
VS0828635	158	5	SP01	417,38
VS0828637	158	5	SP01	441,70
VS0830001	109	5	SP01	495,92
VS0830005	109	5	SP01	501,23
VS0830501	109	5	SP01	535,65
VS0831101	109	5	SP01	505,87
VS0831401	191	1	SP02	250,00
VS0831601	109	5	SP01	501,97
VS0831701	109	5	SP01	626,67
VS0831901	109	5	SP01	501,97
VS0833701	112	5	SP01	584,64
VS0834001	111	5	SP01	462,24
VS0834501	112	5	SP01	459,10
VS0834901	111	5	SP01	495,92
VS0835001	110	5	SP01	522,60
VS0835301	110	5	SP01	627,63
VS0835901	110	5	SP01	560,84
VS0837501	110	5	SP01	527,20
VS0837601	110	5	SP01	527,20
VS0838001	150	1	SP02	102,29
VS0838401	153	1	SP02	32,39
VS0838501	153	1	SP02	21,17
VS0838591	191	1	SP02	30,02
VS0838801	152	1	SP02	102,29
VS0840901	107	5	SP01	358,47
VS0842901	107	5	SP01	439,42
VS0844001	107	5	SP01	324,79
VS0846001	106	1	SP01	272,10
VS0846100	145	1	SP02	84,22
VS0846101	106	1	SP01	272,10
VS0847001	106	1	SP01	312,96
VS0850004	149	1	SP02	25,85
VS0850022	149	1	SP02	19,86
VS0850050	149	1	SP02	22,54
VS0850100	147	1	SP02	84,22
VS0850402	189	1	SP02	23,62
VS0853002	20	5	SP01	782,47
VS0853004	19	5	SP01	782,47
VS0853008	18	5	SP01	782,47
VS0853022	20	5	SP01	841,96
VS0853052	20	5	SP01	939,94
VS0853054	19	5	SP01	939,94
VS0853058	18	5	SP01	939,94
VS0853101	24	1	SP01	1 143,92
VS0853102	24	1	SP01	1 143,92
VS0853111	23	1	SP01	1 143,92
VS0853112	23	1	SP01	1 143,92
VS0853121	24	1	SP01	1 203,01
VS0853122	24	1	SP01	1 203,01
VS0853145	22	1	SP01	1 143,92
VS0853146	22	1	SP01	1 143,92
VS0853151	24	1	SP01	1 298,41
VS0853152	24	1	SP01	1 298,41
VS0853161	23	1	SP01	1 298,41
VS0853162	23	1	SP01	1 298,41
VS0853175	22	1	SP01	1 298,41
VS0853176	22	1	SP01	1 298,41
VS0853201	28	1	SP01	1 550,10
VS0853202	28	1	SP01	1 550,10
VS0853211	27	1	SP01	1 550,10
VS0853212	27	1	SP01	1 550,10
VS0853221	28	1	SP01	1 609,80
VS0853222	28	1	SP01	1 609,80

KOD	str		CL	pln
VS0853245	26	1	SP01	1 550,10
VS0853247	26	1	SP01	1 550,10
VS0853251	28	1	SP01	1 696,30
VS0853252	28	1	SP01	1 696,30
VS0853261	27	1	SP01	1 696,30
VS0853262	27	1	SP01	1 696,30
VS0853275	26	1	SP01	1 696,30
VS0853276	26	1	SP01	1 696,30
VS0853305	21	1	SP01	2 349,82
VS0853306	21	1	SP01	3 203,43
VS0853317	25	1	SP01	2 752,27
VS0853318	25	1	SP01	3 622,00
VS0853327	29	1	SP01	3 178,65
VS0853328	29	1	SP01	4 064,49
VS0853337	33	1	SP01	3 439,18
VS0853338	33	1	SP01	4 325,02
VS0853355	21	1	SP01	2 510,71
VS0853356	21	1	SP01	3 364,32
VS0853357	25	1	SP01	2 916,19
VS0853359	25	1	SP01	3 785,91
VS0853377	29	1	SP01	3 345,57
VS0853378	29	1	SP01	4 231,41
VS0853387	33	1	SP01	3 606,10
VS0853388	33	1	SP01	4 491,46
VS0853401	32	1	SP01	1 805,06
VS0853402	32	1	SP01	1 805,06
VS0853411	31	1	SP01	1 805,06
VS0853412	31	1	SP01	1 805,06
VS0853421	32	1	SP01	1 864,28
VS0853422	32	1	SP01	1 864,28
VS0853445	30	1	SP01	1 805,06
VS0853446	30	1	SP01	1 805,06
VS0853451	32	1	SP01	1 961,92
VS0853452	32	1	SP01	1 961,92
VS0853461	31	1	SP01	1 961,92
VS0853462	31	1	SP01	1 961,92
VS0853475	30	1	SP01	1 961,92
VS0853476	30	1	SP01	1 961,92
VS0855002	37	1	SP01	1 010,59
VS0855004	36	1	SP01	1 010,59
VS0855052	37	1	SP01	1 167,58
VS0855054	36	1	SP01	1 167,58
VS0855201	39	1	SP01	1 821,27
VS0855211	38	1	SP01	1 821,27
VS0855251	39	1	SP01	1 978,12
VS0855261	38	1	SP01	1 978,12
VS0855401	41	1	SP01	2 076,24
VS0855411	40	1	SP01	2 076,24
VS0855451	41	1	SP01	2 221,97
VS0855461	40	1	SP01	2 221,97
VS0857002	86	1	SP01	969,35
VS0857004	86	1	SP01	948,57
VS0857006	85	1	SP01	948,57
VS0857008	85	1	SP01	921,28
VS0857012	88	1	SP01	1 067,49
VS0857013	88	1	SP01	1 110,98
VS0857014	87	1	SP01	1 040,64
VS0857016	87	1	SP01	1 040,64
VS0857022	89	1	SP01	1 246,55
VS0857032	90	1	SP01	1 056,84
VS0857056	91	1	SP01	1 192,42
VS0857058	91	1	SP01	1 165,12
VS0857066	92	1	SP01	1 290,09
VS0858002	8	5	SP01	782,47
VS0858021	8	5	SP01	841,96
VS0858052	8	5	SP01	945,28

KOD	str		CL	pln	KOD	str		CL	pln	KOD	str		CL	pln
VS0858102	10	1	SP01	1 143,92	VS0866697	54	1	SP01	122,21	VS0869397	50	1	SP01	135,61
VS0858121	10	1	SP01	1 197,06	VS0866699	167	1	SP02	530,42	VS0869401	51	5	SP01	271,22
VS0858152	10	1	SP01	1 287,99	VS0866704	100	1	VA02	31,69	VS0869402	51	5	SP01	303,50
VS0858209	14	1	SP01	1 460,83	VS0866735	123	1	SP02	79,74	VS0869404	51	5	SP01	595,36
VS0858211	12	1	SP01	1 548,08	VS0866757	100	1	VA02	57,95	VS0869411	51	5	SP01	368,15
VS0858221	12	1	SP01	1 609,80	VS0866790	125	1	SP02	147,03	VS0869412	51	5	SP01	400,43
VS0858255	12	1	SP01	1 696,30	VS0866792	123	1	SP02	172,93	VS0869414	51	5	SP01	697,36
VS0858259	14	1	SP01	1 601,56	VS0866794	123	1	SP02	32,39	VS0869435	51	5	SP01	502,04
VS0858312	9	1	SP01	2 349,82	VS0866796	125	1	SP02	57,79	VS0869437	51	5	SP01	548,63
VS0858313	11	1	SP01	2 752,27	VS0866801	169	1	SP02	165,34	VS0869445	51	5	SP01	609,50
VS0858321	13	1	SP01	3 178,65	VS0866803	169	1	SP02	68,58	VS0869447	51	5	SP01	656,38
VS0858322	9	1	SP01	3 203,43	VS0866805	183	1	SP02	121,61	VS0869491	51	1	SP01	51,82
VS0858323	11	1	SP01	3 622,00	VS0866811	169	1	SP02	518,46	VS0869495	51	1	SP01	119,44
VS0858331	13	1	SP01	4 064,49	VS0866890	127	1	SP02	147,03	VS0869497	51	1	SP01	135,61
VS0858362	9	1	SP01	2 510,71	VS0866892	127	1	SP02	190,52	VS0870230	157	1	SP01	87,39
VS0858363	11	1	SP01	2 916,19	VS0866894	127	1	SP02	52,77	VS0870235	52	5	SP01	1 010,30
VS0858365	13	1	SP01	3 345,57	VS0866896	127	1	SP02	100,01	VS0870237	52	5	SP01	1 168,34
VS0858372	9	1	SP01	3 364,32	VS0866900	177	1	SP02	128,65	VS0870337	163	5	SP01	752,81
VS0858373	11	1	SP01	3 785,91	VS0866992	125	1	SP02	172,93	VS0870401	165	1	SP01	172,14
VS0858375	13	1	SP01	4 231,41	VS0866994	125	1	SP02	39,22	VS0870435	165	1	SP01	273,32
VS0858401	15	1	SP01	1 804,06	VS0867032	90	1	SP01	846,37	VS0870437	165	1	SP01	303,80
VS0858451	15	1	SP01	1 949,79	VS0867034	90	1	SP01	846,37	VS0870501	156	5	SP01	202,36
VS0860050	149	1	SP02	84,22	VS0867132	92	1	SP01	1 090,22	VS0870503	156	5	SP01	177,76
VS0860901	108	5	SP01	323,92	VS0867134	92	1	SP01	1 090,22	VS0870535	156	5	SP01	353,74
VS0861901	108	5	SP01	358,47	VS0867655	141	1	SP02	28,79	VS0870537	156	5	SP01	384,89
VS0862901	108	5	SP01	439,42	VS0868172	99	1	VA02	386,52	VS0870637	163	1	SP01	608,49
VS0863112	171	1	SP02	32,39	VS0868239	100	1	VA02	83,02	VS0870735	157	1	SP01	955,76
VS0863118	171	1	SP02	85,38	VS0868278	140	1	SP02	31,42	VS0870737	157	1	SP01	1 140,42
VS0863120	179	1	SP02	32,39	VS0868284	127	1	SP02	49,22	VS0870835	157	5	SP01	911,25
VS0863155	171	1	SP02	69,10	VS0868301	165	1	SP02	40,09	VS0870837	157	5	SP01	1 053,69
VS0863160	175	1	SP02	177,66	VS0868339	175	10	SP02	70,97	VS0870847	184	1	SP02	90,73
VS0863165	169	1	SP02	88,45	VS0868613	139	1	SP02	42,40	VS0870848	132	1	SP02	92,97
VS0863509	125	1	SP02	53,81	VS0868625	102	1	VA02	540,96	VS0870901	165	1	SP01	718,70
VS0863540	127	1	SP02	107,16	VS0868627	102	1	VA02	178,59	VS0870935	165	1	SP01	856,94
VS0863565	127	1	SP02	74,33	VS0868732	89	1	SP01	147,78	VS0870937	165	1	SP01	634,58
VS0863850	52	1	SP01	45,99	VS0868749	132	1	SP02	119,58	VS0871301	47	5	SP01	221,06
VS0863851	171	1	SP02	165,34	VS0868830	141	1	SP02	263,55	VS0871302	47	5	SP01	243,18
VS0863854	171	1	SP02	66,60	VS0868832	141	1	SP02	178,90	VS0871303	47	5	SP01	240,94
VS0863859	171	1	SP02	513,15	VS0868834	141	1	SP02	399,53	VS0871335	47	5	SP01	416,16
VS0863860	100	1	VA02	58,43	VS0868850	141	1	SP02	904,59	VS0871337	47	5	SP01	443,74
VS0863861	100	1	VA02	40,62	VS0868901	53	1	SP01	4 447,48	VS0871348	130	1	SP02	76,42
VS0864117	175	1	SP02	33,66	VS0868911	53	1	SP01	4 447,48	VS0871349	131	1	SP02	76,42
VS0864118	175	1	SP02	110,70	VS0868915	54	1	SP01	4 447,48	VS0871401	78	1	SP01	172,14
VS0864166	184	1	SP02	18,42	VS0868921	54	1	SP01	4 148,63	VS0871435	78	1	SP01	303,41
VS0864801	175	1	SP02	304,33	VS0868930	54	1	SP01	525,84	VS0871437	78	1	SP01	337,25
VS0864811	175	1	SP02	628,15	VS0868961	89	1	SP01	4 267,28	VS0871501	48	5	SP01	295,65
VS0865112	173	1	SP02	32,39	VS0868963	89	1	SP01	3 623,81	VS0871503	48	5	SP01	301,41
VS0865128	173	1	SP02	85,38	VS0869001	108	5	SP01	323,92	VS0871535	48	5	SP01	437,87
VS0865148	81	1	VA02	134,33	VS0869101	108	5	SP01	280,46	VS0871537	48	5	SP01	550,72
VS0865801	173	1	SP02	291,93	VS0869201	49	5	SP01	200,44	VS0871548	130	1	SP02	149,74
VS0865803	173	1	SP02	128,65	VS0869211	49	5	SP01	288,87	VS0871549	130	1	SP02	149,74
VS0865811	173	1	SP02	420,62	VS0869235	49	5	SP01	376,16	VS0871550	131	1	SP02	149,74
VS0866112	169	1	SP02	80,10	VS0869237	49	5	SP01	405,53	VS0871735	52	1	SP01	1 021,98
VS0866116	169	1	SP02	33,59	VS0869245	49	5	SP01	474,28	VS0871737	52	1	SP01	1 206,03
VS0866118	169	1	SP02	107,09	VS0869247	49	5	SP01	503,65	VS0872204	119	1	VA02	83,02
VS0866163	169	1	SP02	177,66	VS0869291	49	1	SP01	51,82	VS0872206	119	1	VA02	135,66
VS0866580	167	1	SP02	73,36	VS0869295	49	1	SP01	119,44	VS0872235	72	1	SP01	716,77
VS0866603	167	10	SP02	10,24	VS0869297	49	1	SP01	135,61	VS0872237	72	1	SP01	873,62
VS0866625	127	1	SP02	91,45	VS0869301	50	5	SP01	200,44	VS0872335	164	1	SP01	450,93
VS0866640	129	1	SP02	215,82	VS0869311	50	5	SP01	288,87	VS0872337	164	1	SP01	575,16
VS0866690	167	1	SP02	147,03	VS0869335	50	5	SP01	376,16	VS0872501	156	5	SP01	202,36
VS0866692	167	1	SP02	172,93	VS0869337	50	5	SP01	405,53	VS0872535	156	5	SP01	353,74
VS0866693	167	1	SP02	121,61	VS0869345	50	5	SP01	474,28	VS0872537	156	5	SP01	384,89
VS0866694	167	1	SP02	32,39	VS0869347	50	5	SP01	503,65	VS0872601	47	5	SP01	295,65
VS0866695	131	1	SP02	16,14	VS0869391	50	1	SP01	51,82	VS0872635	47	5	SP01	437,87
VS0866696	167	1	SP02	69,60	VS0869395	50	1	SP01	119,44	VS0872637	47	5	SP01	550,72

KOD	str		CL	pln	KOD	str		CL	pln	KOD	str		CL	pln
VS0872641	47	5	SP01	350,95	VS0876027	63	1	SP03	1 618,78	VS0877057	57	1	SP03	1 325,11
VS0872642	47	5	SP01	347,64	VS0876031	62	1	SP03	1 618,78	VS0877305	55	1	SP03	1 199,35
VS0872801	48	5	SP01	221,06	VS0876033	62	1	SP03	1 618,78	VS0877307	55	1	SP03	1 199,35
VS0872835	48	5	SP01	416,16	VS0876041	63	1	SP03	1 618,78	VS0877311	55	1	SP03	1 199,35
VS0872837	48	5	SP01	443,74	VS0876043	63	1	SP03	1 618,78	VS0877313	55	1	SP03	1 199,35
VS0874011	129	1	SP02	151,59	VS0876045	63	1	SP03	1 618,78	VS0877315	55	1	SP03	1 199,35
VS0874012	128	1	SP02	113,04	VS0876047	63	1	SP03	1 618,78	VS0877317	55	1	SP03	1 199,35
VS0874013	129	1	SP02	707,53	VS0876051	62	1	SP03	1 618,78	VS0877331	56	1	SP03	1 325,11
VS0874015	129	1	SP02	239,20	VS0876053	62	1	SP03	1 618,78	VS0877332	58	1	SP03	1 325,11
VS0874016	129	1	SP02	2 374,76	VS0876055	62	1	SP03	1 618,78	VS0877333	56	1	SP03	1 325,11
VS0874022	129	1	SP02	165,23	VS0876057	62	1	SP03	1 618,78	VS0877334	58	1	SP03	1 325,11
VS0874203	128	1	SP02	475,67	VS0876305	62	1	SP03	1 618,78	VS0877335	56	1	SP03	1 325,11
VS0874211	128	1	SP02	390,55	VS0876307	62	1	SP03	1 618,78	VS0877336	58	1	SP03	1 325,11
VS0874212	128	1	SP02	941,32	VS0876311	63	1	SP03	1 618,78	VS0877337	56	1	SP03	1 325,11
VS0874215	128	1	SP02	1 264,27	VS0876313	63	1	SP03	1 618,78	VS0877338	58	1	SP03	1 325,11
VS0874216	128	1	SP02	1 952,74	VS0876315	63	1	SP03	1 618,78	VS0877341	57	1	SP03	1 325,11
VS0874220	128	5	SP02	117,67	VS0876317	63	1	SP03	1 618,78	VS0877342	58	1	SP03	1 325,11
VS0875001	73	1	SP01	305,91	VS0876321	63	1	SP03	1 618,78	VS0877343	57	1	SP03	1 325,11
VS0875011	75	1	SP01	319,97	VS0876323	63	1	SP03	1 618,78	VS0877344	58	1	SP03	1 325,11
VS0875035	73	1	SP01	500,00	VS0876335	62	1	SP03	1 618,78	VS0877345	57	1	SP03	1 325,11
VS0875037	73	1	SP01	531,70	VS0876337	62	1	SP03	1 618,78	VS0877346	58	1	SP03	1 325,11
VS0875047	75	1	SP01	547,65	VS0876341	63	1	SP03	1 618,78	VS0877347	57	1	SP03	1 325,11
VS0875109	135	1	SP02	73,11	VS0876343	63	1	SP03	1 618,78	VS0877348	58	1	SP03	1 325,11
VS0875110	135	1	SP02	73,11	VS0876601	64	1	SP03	1 618,78	VS0877351	57	1	SP03	1 325,11
VS0875208	78	1	SP01	106,18	VS0876603	64	1	SP03	1 618,78	VS0877352	59	1	SP03	1 325,11
VS0875297	135	1	SP02	73,11	VS0876605	64	1	SP03	1 618,78	VS0877353	57	1	SP03	1 325,11
VS0875298	135	1	SP02	73,11	VS0876607	64	1	SP03	1 618,78	VS0877354	59	1	SP03	1 325,11
VS0875305	135	1	SP02	192,50	VS0876611	64	1	SP03	1 618,78	VS0877355	57	1	SP03	1 325,11
VS0875307	135	1	SP02	192,50	VS0876613	64	1	SP03	1 618,78	VS0877356	59	1	SP03	1 325,11
VS0875309	135	1	SP02	192,50	VS0876615	64	1	SP03	1 618,78	VS0877357	57	1	SP03	1 325,11
VS0875311	135	1	SP02	192,50	VS0876617	64	1	SP03	1 618,78	VS0877358	59	1	SP03	1 325,11
VS0875313	184	1	SP02	192,50	VS0876621	64	1	SP03	1 618,78	VS0877361	58	1	SP03	1 325,11
VS0875315	136	1	SP02	192,50	VS0876623	64	1	SP03	1 618,78	VS0877362	59	1	SP03	1 325,11
VS0875317	184	1	SP02	192,50	VS0876625	64	1	SP03	1 618,78	VS0877363	58	1	SP03	1 325,11
VS0875319	136	1	SP02	192,50	VS0876627	64	1	SP03	1 618,78	VS0877364	59	1	SP03	1 325,11
VS0875321	135	1	SP02	418,27	VS0876631	65	1	SP03	1 618,78	VS0877365	58	1	SP03	1 325,11
VS0875323	135	1	SP02	418,27	VS0876633	65	1	SP03	1 618,78	VS0877366	59	1	SP03	1 325,11
VS0875324	135	1	SP02	418,27	VS0876635	65	1	SP03	1 618,78	VS0877367	58	1	SP03	1 325,11
VS0875325	135	1	SP02	464,23	VS0876637	65	1	SP03	1 618,78	VS0877368	59	1	SP03	1 325,11
VS0875327	135	1	SP02	464,23	VS0876831	65	1	SP03	1 618,78	VS0877601	55	1	SP03	1 132,47
VS0875328	135	1	SP02	464,23	VS0876833	65	1	SP03	1 618,78	VS0877603	55	1	SP03	1 132,47
VS0875329	134	1	SP02	141,83	VS0876835	65	1	SP03	1 618,78	VS0877605	55	1	SP03	1 132,47
VS0875332	134	1	SP02	141,83	VS0876837	65	1	SP03	1 618,78	VS0877607	55	1	SP03	1 132,47
VS0875333	134	1	SP02	141,83	VS0877001	55	1	SP03	1 199,35	VS0877611	55	1	SP03	1 132,47
VS0875334	134	1	SP02	149,38	VS0877003	55	1	SP03	1 199,35	VS0877613	55	1	SP03	1 132,47
VS0875335	134	1	SP02	141,83	VS0877005	55	1	SP03	1 199,35	VS0877615	55	1	SP03	1 132,47
VS0875336	134	1	SP02	140,21	VS0877007	55	1	SP03	1 199,35	VS0877617	55	1	SP03	1 132,47
VS0875338	134	1	SP02	141,83	VS0877011	55	1	SP03	1 199,35	VS0877621	56	1	SP03	1 132,47
VS0875339	134	1	SP02	141,83	VS0877013	55	1	SP03	1 199,35	VS0877623	56	1	SP03	1 132,47
VS0875341	135	1	SP02	80,57	VS0877015	55	1	SP03	1 199,35	VS0877625	56	1	SP03	1 132,47
VS0875501	73	1	SP01	305,91	VS0877017	55	1	SP03	1 199,35	VS0877627	56	1	SP03	1 132,47
VS0875511	75	1	SP01	319,97	VS0877021	56	1	SP03	1 199,35	VS0877631	56	1	SP03	1 258,86
VS0875535	73	1	SP01	500,00	VS0877023	56	1	SP03	1 199,35	VS0877633	56	1	SP03	1 258,86
VS0875537	73	1	SP01	531,70	VS0877025	56	1	SP03	1 199,35	VS0877635	56	1	SP03	1 258,86
VS0875547	75	1	SP01	547,65	VS0877027	56	1	SP03	1 199,35	VS0877637	56	1	SP03	1 258,86
VS0876001	62	1	SP03	1 618,78	VS0877031	56	1	SP03	1 325,11	VS0877641	57	1	SP03	1 258,86
VS0876003	62	1	SP03	1 618,78	VS0877033	56	1	SP03	1 325,11	VS0877643	57	1	SP03	1 258,86
VS0876005	62	1	SP03	1 618,78	VS0877035	56	1	SP03	1 325,11	VS0877645	57	1	SP03	1 258,86
VS0876007	62	1	SP03	1 618,78	VS0877037	56	1	SP03	1 325,11	VS0877647	57	1	SP03	1 258,86
VS0876011	63	1	SP03	1 618,78	VS0877041	57	1	SP03	1 325,11	VS0877651	57	1	SP03	1 258,86
VS0876013	63	1	SP03	1 618,78	VS0877043	57	1	SP03	1 325,11	VS0877653	57	1	SP03	1 258,86
VS0876015	63	1	SP03	1 618,78	VS0877045	57	1	SP03	1 325,11	VS0877655	57	1	SP03	1 258,86
VS0876017	63	1	SP03	1 618,78	VS0877047	57	1	SP03	1 325,11	VS0877657	57	1	SP03	1 258,86
VS0876021	63	1	SP03	1 618,78	VS0877051	57	1	SP03	1 325,11	VS0877901	61	1	SP03	992,64
VS0876023	63	1	SP03	1 618,78	VS0877053	57	1	SP03	1 325,11	VS0877903	61	1	SP03	992,64
VS0876025	63	1	SP03	1 618,78	VS0877055	57	1	SP03	1 325,11	VS0877905	61	1	SP03	992,64

KOD	str		CL	pln	KOD	str		CL	pln
VS0877907	61	1	SP03	992,64	VS0878864	60	1	SP03	1 354,15
VS0877931	61	1	SP03	992,64	VS0878865	60	1	SP03	1 354,15
VS0877933	61	1	SP03	992,64	VS0878866	60	1	SP03	1 354,15
VS0877935	61	1	SP03	992,64	VS0878867	60	1	SP03	1 354,15
VS0877937	61	1	SP03	992,64	VS0878868	60	1	SP03	1 158,78
VS0877961	61	1	SP03	899,57	VS0878869	60	1	SP03	1 158,78
VS0877963	61	1	SP03	899,57	VS0878870	60	1	SP03	1 158,78
VS0877965	61	1	SP03	899,57	VS0878871	60	1	SP03	1 158,78
VS0877967	61	1	SP03	899,57	VS0878872	69	1	SP03	83,83
VS0878001	67	1	SP03	1 864,77	VS0878873	69	1	SP03	83,83
VS0878003	67	1	SP03	1 864,77	VS0878874	69	1	SP03	83,83
VS0878005	67	1	SP03	1 864,77	VS0878875	69	1	SP03	83,83
VS0878007	67	1	SP03	1 864,77	VS0878879	60	1	SP03	1 158,78
VS0878011	66	1	SP03	1 864,77	VS0879001	69	1	SP03	685,99
VS0878021	67	1	SP03	1 864,77	VS0879003	69	1	SP03	685,99
VS0878023	67	1	SP03	1 864,77	VS0879005	69	1	SP03	685,99
VS0878033	67	1	SP03	1 864,77	VS0879007	69	1	SP03	685,99
VS0878035	67	1	SP03	1 864,77	VS0879011	69	1	SP03	685,99
VS0878037	67	1	SP03	1 864,77	VS0879013	69	1	SP03	685,99
VS0878045	68	1	SP03	1 864,77	VS0879015	69	1	SP03	685,99
VS0878047	68	1	SP03	1 864,77	VS0879017	69	1	SP03	685,99
VS0878051	68	1	SP03	1 864,77	VS0881153	89	1	SP01	129,94
VS0878053	68	1	SP03	1 864,77					
VS0878055	68	1	SP03	1 864,77					
VS0878057	68	1	SP03	1 864,77					
VS0878061	66	1	SP03	1 864,77					
VS0878063	66	1	SP03	1 864,77					
VS0878065	66	1	SP03	1 864,77					
VS0878067	66	1	SP03	1 864,77					
VS0878301	67	1	SP03	1 864,77					
VS0878303	67	1	SP03	1 864,77					
VS0878315	66	1	SP03	1 864,77					
VS0878317	66	1	SP03	1 864,77					
VS0878321	67	1	SP03	1 864,77					
VS0878323	67	1	SP03	1 864,77					
VS0878331	67	1	SP03	1 864,77					
VS0878333	67	1	SP03	1 864,77					
VS0878355	68	1	SP03	1 864,77					
VS0878357	68	1	SP03	1 864,77					
VS0878365	66	1	SP03	1 864,77					
VS0878367	66	1	SP03	1 864,77					
VS0878601	65	1	SP03	1 864,77					
VS0878603	65	1	SP03	1 864,77					
VS0878605	65	1	SP03	1 864,77					
VS0878607	65	1	SP03	1 864,77					
VS0878623	66	1	SP03	1 864,77					
VS0878625	66	1	SP03	1 864,77					
VS0878627	66	1	SP03	1 864,77					
VS0878801	65	1	SP03	1 864,77					
VS0878803	65	1	SP03	1 864,77					
VS0878821	66	1	SP03	1 864,77					
VS0878823	66	1	SP03	1 864,77					
VS0878825	66	1	SP03	1 864,77					
VS0878827	66	1	SP03	1 864,77					
VS0878851	68	1	SP03	1 117,88					
VS0878852	68	1	SP03	1 117,88					
VS0878853	68	1	SP03	1 117,88					
VS0878854	68	1	SP03	1 117,88					
VS0878855	68	1	SP03	1 117,88					
VS0878856	68	1	SP03	1 117,88					
VS0878857	68	1	SP03	1 117,88					
VS0878858	68	1	SP03	1 117,88					
VS0878860	60	1	SP03	1 354,15					
VS0878861	60	1	SP03	1 354,15					
VS0878862	60	1	SP03	1 354,15					
VS0878863	60	1	SP03	1 354,15					

Handwriting practice sheet with 20 horizontal lines. The first 10 lines are pre-filled with a series of 10 different geometric shapes: a vertical bar, a semi-circle, a triangle, a circle, a square, a diamond, a hexagon, an octagon, a star, and a spiral. The remaining 10 lines are blank for practice.

Handwriting practice lines with 12 icons on the right side: a vertical bar, a semi-circle, a flame, a teardrop, a swirl, a hook, a swastika, a U-shape, a water drop, a spiral, a triangle, a vertical bar, and a wavy line.

A series of horizontal lines for handwriting practice, with a vertical column of ten icons on the right side. The icons, from top to bottom, are: a circle with a vertical line through the center, a circle with a horizontal line through the center, a circle with a flame-like shape inside, a circle with a teardrop shape inside, a circle with a curved arrow pointing right, a circle with a swastika-like symbol, a circle with a hand-like shape, a circle with two teardrop shapes inside, a circle with a spiral inside, and a circle with a triangle inside. Below these icons are several more horizontal lines for practice.

SYSTEMY KANALIZACYJNE
WASTE SYSTEMS
SYSTEME EVACUATION



SYSTEMY WODOCIAGOWE
PRESSURE POTABLE WATER SYSTEMS
SYSTEME D'EAU SOUS PRESSION



SYSTEMY WIELOWARSTWOWE
SUPPLY SYSTEMS
SYSTEME ALIMENTATION



SPŁUCZKI
FLUSH SYSTEMS
RESERVOIR DE CHASSE



ODWODNIENIA
PRYSZNICOWE
BATHROOM SYSTEMS
SYSTEME SALLE DE BAIN



SYFONY
TRAPS
SIPHON



OGRZEWANIE PODŁOGOWE
RADIANT SYSTEMS
SYSTEME PLANCHER CHAUFFANT



ODWODNIENIA DACHOWE
DRAINAGE SYSTEMS
SYSTEME EVACUATION PLUVIALE



SYSTEM ODZYSKU
CIEPŁA HRV
HRV SYSTEM
SYSTEME VMC



ACADEMY



SYSTEMY KANALIZACYJNE
SEWER SYSTEMS
SYSTEME GRAVITAIRE



UZDATNIANIE WODY
WATER TREATMENT
TRAITEMENT EAU



INSTALACJE SANITARNE
PLUMBING
BÂTIMENT

BUDOWNICTWO
BUILDING
ASSAINISSEMENT

valsir[®]
QUALITY FOR PLUMBING

Valsir Polska Sp. z o.o.
ul. Przemysłowa 7A
32-050 Skawina
Tel. +4812 276.51.00
Fax +4812 276.51.01
e-mail: valsir@valsir.pl
www.valsir.pl



L07-68216 - April 2022

